

BEE033-ELECTRIC AND HYBRID VEHICLES

UNIT 1

ELECTRIC VEHICLES

Introduction

An electric vehicle, also called an electric drive vehicle, uses one or more electric motors or traction motors for propulsion. An electric vehicle may be powered through a collector system by electricity from off-vehicle sources, or may be self-contained with a battery, solar panels or a generator to convert fuel to electricity.^[1] EVs include road and rail vehicles, surface and underwater vessels, electric aircraft and electric spacecraft.

EVs first came into existence in the mid-19th century, when electricity was among the preferred methods for motor vehicle propulsion, providing a level of comfort and ease of operation that could not be achieved by the gasoline cars of the time. The internal combustion engine has been the dominant propulsion method for motor vehicles for almost 100 years, but electric power has remained commonplace in other vehicle types, such as trains and smaller vehicles of all types.

In the 21st century, EVs saw a resurgence due to technological developments and an increased focus on renewable energy.

What is a hybrid? A hybrid vehicle combines any two power (energy) sources. Possible combinations include diesel/electric, gasoline/fly wheel, and fuel cell (FC)/battery. Typically, one energy source is storage, and the other is conversion of a fuel to energy. The combination of two power sources may support two separate propulsion systems. Thus to be a True hybrid, the vehicle must have at least two modes of propulsion.

For example, a truck that uses a diesel to drive a generator, which in turn drives several electrical motors for all-wheel drive, is *not a hybrid*. But if the truck has electrical energy storage to provide a second mode, which is electrical assists, then it is a hybrid Vehicle.

These two power sources may be paired in series, meaning that the gas engine charges the batteries of an electric motor that powers the car, or in parallel, with both mechanisms driving the car directly.

Hybrid electric vehicle (HEV)

Consistent with the definition of hybrid above, the hybrid electric vehicle combines a gasoline engine with an electric motor. An alternate arrangement is a diesel engine and an electric motor (figure 1).

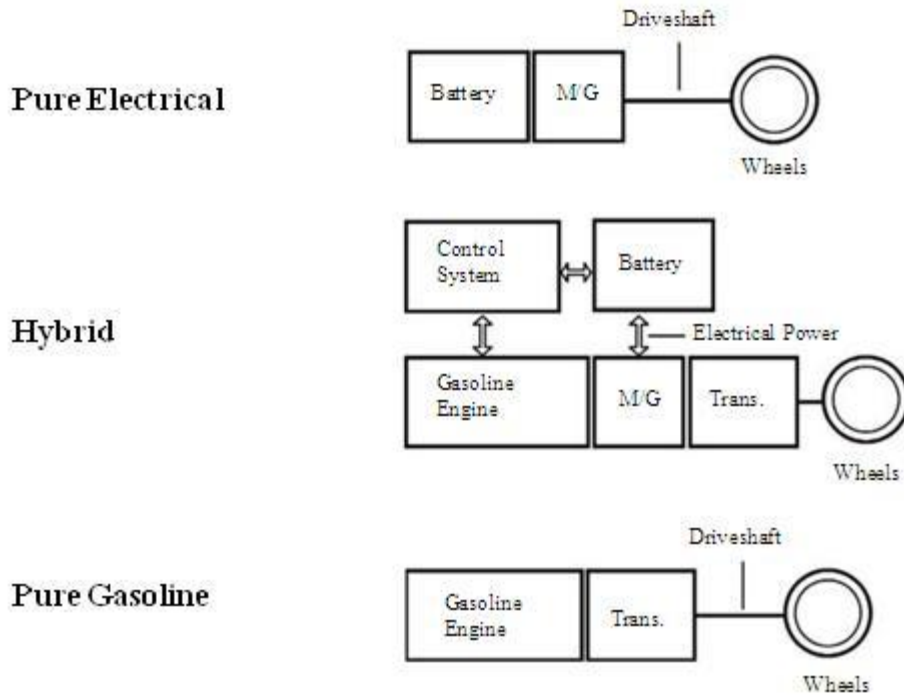

- Figure 1: Components of a hybrid Vehicle that combines a pure gasoline with a pure EV.

As shown in Figure 1, a HEV is formed by merging components from a pure electrical vehicle and a pure gasoline vehicle. The Electric Vehicle (EV) has an M/G which allows regenerative braking for an EV; the M/G installed in the HEV enables regenerative braking. For the HEV, the M/G is tucked directly behind the engine. In Honda hybrids, the M/G is connected directly to the engine. The transmission appears next in line. This arrangement has two torque producers; the M/G in motor mode, M-mode, and the gasoline engine. The battery and M/G are con

HEVs are a combination of electrical and mechanical components. Three main sources of electricity for hybrids are batteries, FCs, and capacitors. Each device has a low cell voltage, and, hence, requires many cells in series to obtain the voltage demanded by an HEV. Difference in the source of Energy can be explained as:

- The FC provides high energy but low power.
- The battery supplies both modest power and energy.
- The capacitor supplies very large power but low energy.

The components of an electrochemical cell include anode, cathode, and electrolyte (shown in fig2). The current flow both internal and external to the cell is used to describe the current loop.

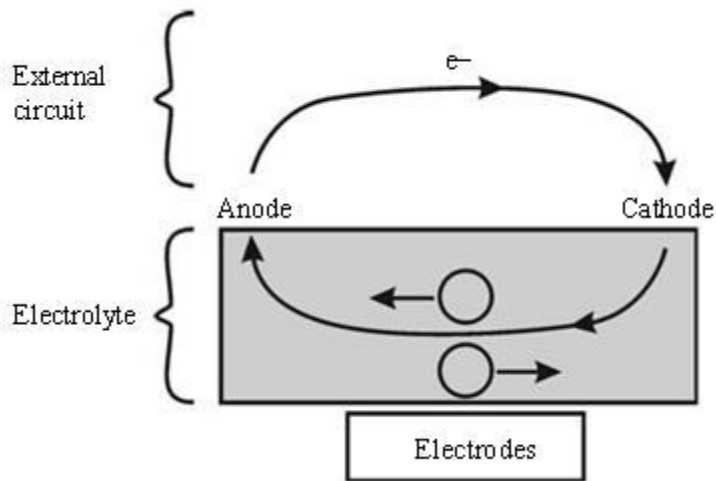

Figure 2: An electrode, a circuit for a cell which is converting chemical energy to electrical energy. The motion of negative charges is clockwise and forms a closed loop through external wires and load and the electrolyte in the cell.

A critical issue for both battery life and safety is the precision control of the Charge/Discharge cycle. Overcharging can be traced as a cause of fire and failure.

Applications impose two boundaries or limitations on batteries. The first limit, which is dictated by battery life, is the minimum allowed State of Charge. As a result, not all the installed battery energy can be used. The battery feeds energy to other electrical equipment, which is usually the inverter. This equipment can use a broad range of input voltage, but cannot accept a low voltage. The second limit is the minimum voltage allowed from the battery.

Mechanics

A non-electric vehicle contains an internal combustion engine and related parts such as a fuel tank, fuel lines, fuel-injection systems, cooling system, and an exhaust system. Electric cars, on the other hand, are powered directly by electricity rather than a combustible fuel.

An electric car has an array of rechargeable batteries, at least one electric motor, a controller that feeds electricity to the electric motor(s) based on input from the accelerator pedal, and a charging system. In modern electric passenger cars, the electricity to power the electric motor(s) is provided by a rechargeable battery pack, an onboard gasoline-engine generator, or a hydrogen fuel cell.

In most electric cars, such as the Nissan Leaf, electricity is supplied by a rechargeable battery

pack that can be plugged into one of three power sources: a standard household outlet, an upgraded home charging system that cuts recharging time in half, or a quick-charge station provided by a city or public utility. When an electric car's battery pack needs to be recharged, plugging the car in to one of these three sources is as easy as plugging in a heavy-duty extension cord. It can take as little as one hour to recharge the car using a high-voltage public quick-charge station or as long as 12 hours using a standard household outlet.

The Chevrolet Volt is a plug-in hybrid electric vehicle that features a small gas-powered engine/generator. The Volt's battery can be charged by a standard household 120-volt outlet in approximately 10 hours. When the battery pack is empty, the Volt's gasoline engine turns on and generates energy that is converted to electricity, which extends the driving range by an additional 300 miles or so.

The Honda FCX Clarity is a Fuel Cell Electric Vehicle (FCEV) that combines hydrogen with oxygen to make electricity. The only byproduct of this vehicle is water vapor, which makes it one of the most environmentally friendly cars on the road. FCEVs must be refueled at a designated hydrogen refueling station, just as a normal car is refilled at a gas station.

Engineers are also starting to build special solar-powered cars as demonstration vehicles for how such technology works. These experimental vehicles are exploratory in nature and are not suitable for daily driving. Some vehicles, such as the Toyota Prius, do employ solar-cell technology to run ancillary vehicle systems.

Within a normal car, a series of messy, chaotic, minor explosions are constantly happening inside the engine, producing tailpipe emissions, which electric cars don't produce. A traditional car takes the energy from the repetitive explosions to create motion. In an electric car, you're essentially taking the energy from your local power station and using that energy to produce motion. That's why electric cars are almost dangerously quiet (they're not running on constant explosions) and why the availability of charging stations is so important (to draw more energy from a power plant). Many electric car owners will choose to install a wall charger in their home for convenience's sake. It costs about \$2.64 to reach a full charge on a typical electric car battery with a 70-mile range. When combined with on-roof solar panels, the cost to charge an electric car can become almost nil (and you'll usually get a tax break, too). Usually, an electric car can be charged overnight (in about six hours), but Telsa's "Supercharger" stations can get electric cars charged in about an hour.

The new technologies in electric cars have lower lifetime emissions from cradle to grave, a lower cost of maintenance, and less noise and vibrations. While the main concern for many is still the range versus the amount of miles driven per day (as the range on these vehicles is often lower than 70 miles per charge), the costs have lowered substantially, with the cheapest versions starting at barely over \$21,000. There's a reason why the first electric car was invented in 1859 but not refined until now: change is difficult because of the complexity of creating new charging stations, improving the technology so it's practical to use, and essentially reinventing a lot of how we think about cars. But while this progress has been slow at times, it's been for the better, and will continue to improve in the future.

Road Design Fundamentals

Road Design

The alignment of a highway is a three-dimensional element, designed in x, y, and z coordinates illustrated in Figure 2. However, in highway design practice, threedimensional design computations are cumbersome and, what is perhaps more important, the actual implementation and construction of a design based on three-dimensional coordinates has traditionally been prohibitively difficult. (Although, contractors have begun using GPS technology utilizing 3-D surface files to construct jobs.) As a consequence, the three-dimensional highway alignment is reduced to two two dimensional alignment problems, as illustrated in Fig. 3. Furthermore, distance is measured along the centerline of the highway in terms of stations, with each station consisting of 100ft of highway alignment distance.

Vertical Curve Fundamentals:

Changes in existing terrain and differential between connecting road grades require the construction of vertical curves. Construction of a vertical curve is generally a costly operation requiring the movement of significant amounts of earthen material. Thus one of the primary challenges facing highway designers is to minimize construction costs by maximizing the earth cut and fill balance and keeping the length of the vertical curve to a minimum while still providing an adequate level of safety. An appropriate level of safety is usually defined as the level of safety that provides drivers with significant sight distance to allow them to safely stop their vehicles to avoid collisions with objects obstructing their forward motion

PROPULSION SYSTEM DESIGN

I. INTRODUCTION

To reduce the severe problem of Air Pollution in this century caused by fuel emission from Automobiles, one answer has been developed called Zero Emission Vehicles (Electric Vehicles) which are powered by onboard batteries and does not cause harmful tailpipe emissions. Fuel cell electric Vehicle has long term potential to be the vehicle of future [1]. A design methodology is presented based on vehicle dynamics and is aimed at finding the optimal torquespeed profile to meet the operational constraints with minimum power requirement. The more the motor can operate in constant power, the less the acceleration power requirement will be. Here, the components are designed in such a way that the motors are imparted maximum torque-speed characteristics. Simulation of electric vehicle propulsion system is done using drive cycle input and the performance is evaluated.

II. ELECTRIC VEHICLE STRUCTURE

An Electric Vehicle contains 3 main parts

(1) Energy Source. (2) Power Converter. (3) Traction Motor.

. Figure 1. Electric vehicle power train block diagram The energy sources consist of Rechargeable batteries, ultra capacitors and fuel cell. The electronic controller controls the flow of power from energy source to traction motors. The power converter adjusts the voltage according to the load demand. Li-Ion battery is better preferred as energy source because of long life and high energy density but it is not economically feasible [3]. The vehicle dynamics are studied first and the values of tractive force, Motor Torque and Motor angular speed is found out with the help of equations given below. Follow the type sizes specified in Table I. As an aid in

gauging type size, 1 point is about 0.35 mm.. So, at rated speed of 3000 Rpm, the rated power will be 60Kw and maximum motor power will be 80Kw respectively. Figure 2. Power versus speed Figure 3. Torque versus speed Similarly, In Torque versus Speed plot, at rated speed of 3000 Rpm the rated torque will be 220 Nm. Figure 4. Speed (rpm) versus time (seconds). From the vehicle dynamics, the following above plots are done and the rated values of Power, Torque and speed is obtained whose values are used as an input for traction motor sizing. Rated speed, Rated motor Power and Rated motor torque will be used as an input for designing the parameters of Induction motor. IV.

TRACTION MOTOR SIZING From the plots obtained in Fig. 2, Fig. 3 and Fig. 4, the following motor design data's are obtained. International Journal of Electronics and Electrical Engineering Vol. 3, No. 1, February, 2015 ©2015 Engineering and Technology Publishing 15

TABLE II. MOTOR DESIGN DATA

Parameter	Value
Rated Motor Speed	3000 Rpm
Maximum Motor Speed	7000 Rpm
Rated Motor Power	60 Kw
Maximum Motor Power	80 Kw
Rated Motor Torque	220 Nm

Based on the certain equations of electrical machine design, the following optimal designing of induction motor done is shown below.

TABLE III. OPTIMAL DESIGN OF INDUCTION MOTOR

Parameter	Value
Output Power	35KW
No. of Poles	2
Stator Diameter(Minimum cost)	0.196m
Stator length (Minimum cost)	0.221m
Flux per pole	0.0238Weber
Total conductors	300.492
Stator current per phase	79.456Ampere
Stator area	22.70mm ²
Stator diameter(good power factor)	0.165m
Stator Length(good power factor)	0.124m
Flux per pole	0.0383 Weber
Total Conductors	186.72
Stator diameter(Good efficiency)	0.153 m
Stator length(Good efficiency)	0.36 m
Flux per pole	0.0346 Weber
Total conductors.	206.7
Stator diameter(good overall design)	0.385 m
Stator length(good overall design)	0.604 m
Flux per pole	0.146 Weber
Total conductors	48.98
No. of Rotor slots	61
Rotor bar current	54.21 A
Total rotor copper loss	232.68 W
Slip	0.0065
Stator Leakage Reactance	1.0812 Ω
Magnetizing current	6.085 A
Magnetizing reactance	41.72 Ω
Stator resistance per phase	0.048 Ω
Total resistance per phase	0.0043 Ω

The stator and Rotor designing of Induction motor is done in C++ language using the rated values of motor obtained in Table II and using the designing procedure of Electrical machine designing, the stator and rotor parameters are obtained. The equivalent circuit parameters obtained is thus adjusted to increase the range of constant power region. On increasing the value of Rotor resistance, the range of constant power region increases which is shown below. Figure 5. Torque versus speed showing constant power region for 2 graphs For Graph 1, the input parameters are adjusted to the following values Rotor resistance=0.258Ω, Rotor reactance=0.507Ω Stator resistance=0.461Ω, Stator reactance=0.309Ω Magnetizing reactance=30.74Ω For Graph 2, the input parameters are adjusted to the following values Rotor resistance=0.982Ω, Rotor reactance=0.507Ω Stator resistance=0.461Ω, Stator reactance=0.309Ω Magnetizing reactance=30.74Ω V.

MATLAB SIMULINK MODEL

After the analytical approach, the final results are obtained from Matlab Simulink modeling to assess the performance and range of the proposed Electric Vehicle design. The simulation model consists of the following blocks: (1) Electrical Subsystem. (2) Vehicle Dynamics. (3) Energy management System. The traction motor used is the Permanent Magnet Synchronous motor (PMSM) and three phase Induction motor (IM). The power converter used is the DC-DC bidirectional class C chopper. The battery used is Ni-Mh (Nickel Metal hydride). The gain is changed for Different values and the output is recorded. The model used for simulation is a fuel cell electric vehicle which is shown in Fig. 6. Graph 1 Graph 2 International Journal of Electronics and Electrical Engineering Vol. 3, No. 1, February, 2015 ©2015 Engineering and Technology Publishing 16 Figure 6. Fuel cell electric vehicle model. Drive Cycle: A drive cycle is a standardized driving pattern. This pattern is described by means of a velocity–time table. Now putting the New York City drive cycle as an input. Above model is run again and the output graph between reference and actual speed is plotted under considerable time period. Further simulation for PMSM with accelerator and later with Induction motor is done for 15 seconds for better understanding of the motor power, Fuel cell power and battery power which is shown in Fig. 7. Figure 7. Fuel cell electric vehicle simulation output graph. Later simulation of the same model is done with New York City drive cycle for 540 seconds to compare the efficiency and working of both PMSM and Induction motor. Figure 8. Drive cycle output of PMSM electric vehicle for 78 seconds The drive cycle in Fig. 8 shows that the actual car speed does not attend the reference speed which is due to machine inefficiency. The drive cycle shows the clear difference however, the validation is not there. The simulation result of the proposed model was satisfactory and shows correct performance of the system. Figure 9. Drive cycle output of induction motor electric vehicle for 50 seconds. From the above two simulation outputs, it is clear that PMSM gives better simulation results than Induction Motor. Their advantages are [4]. (1) Since, the magnetic field is excited by high energy of magnetic fields; it results in high efficiency and easy speed control. (2) They have longer operating lives and an increased reliability and Brushless DC motor has been recommended for high performance electric vehicle [5]. Recent research has indicated that the permanent magnet synchronous motor and brushless dc motor (BLDC) can compete with Induction motor for electric vehicle propulsion [6]. Eventually, the simulation results for Rotor speed, Rotor and Stator current responses and Time response of Torque of 3 phase Induction motor is obtained. Fig. 10 shows that the rotor-speed curve of three phase Induction motor (wound rotor type).With respect to the above figure, the rotor speed is gradually increased to the rated speed. The rated speed is 1150rpm and it is reached at nearly 0.8seconds. International Journal of Electronics and Electrical Engineering Vol. 3, No. 1, February, 2015 ©2015 Engineering and Technology Publishing 17 Figure 10. Rotor speed curve of 3phase induction motor Figure 11. Rotor and stator current responses of 3phase induction motor The rotor and stator current responses of the threephase induction motor are shown in Fig. 11. The rotor current fluctuates between 0 and 0.7 second. The stator current is drawn about 10 A at 0.8 second as shown in the figure. In Fig. 12, the time response of electromagnetic torque in the three-phase induction motor is expressed. The electromagnetic

torque of three-phase induction motor is firstly variable in 0 to 0.4 second. Then the rated torque is reached at 0.8 second. The rated torque can be seen 10 Nm as shown in the figure below. Figure 12. Time response of electromagnetic torque in 3phase induction motor VI.

CONCLUSION Both PMSM and Induction Motor shows good characteristics for application in Electric Vehicles but PMSM are more preferred because of higher efficiency, higher power density and low cost [7]. But the only disadvantage with PMSM is that they are not self-starting motors .The range of Constant power region of Traction motor can be increased by increasing the value of rotor resistance. The vehicle's operational constraints can be met with minimum power if the vehicle is operated mostly in constant power region[8]. Drive cycle can be prepared to evaluate the performance of electric vehicle through simulation and this reduces the time of testing the road and the fatigue engineers has to ta

UNIT II

BATTERY

Components of Cells and Batteries

Cells are comprised of 3 essential components.

- The Anode is the negative or reducing electrode that releases electrons to the external circuit and oxidizes during and electrochemical reaction.
- The Cathode is the positive or oxidizing electrode that acquires electrons from the external circuit and is reduced during the electrochemical reaction.
- The Electrolyte is the medium that provides the *ion* transport mechanism between the cathode and anode of a cell. Electrolytes are often thought of as liquids, such as water or other solvents, with dissolved salts, *acids*, or *alkalis* that are required for *ionic conduction*. It should however be noted that many batteries including the conventional (AA/AAA/D) batteries contain solid electrolytes that act as ionic conductors at room temperature.

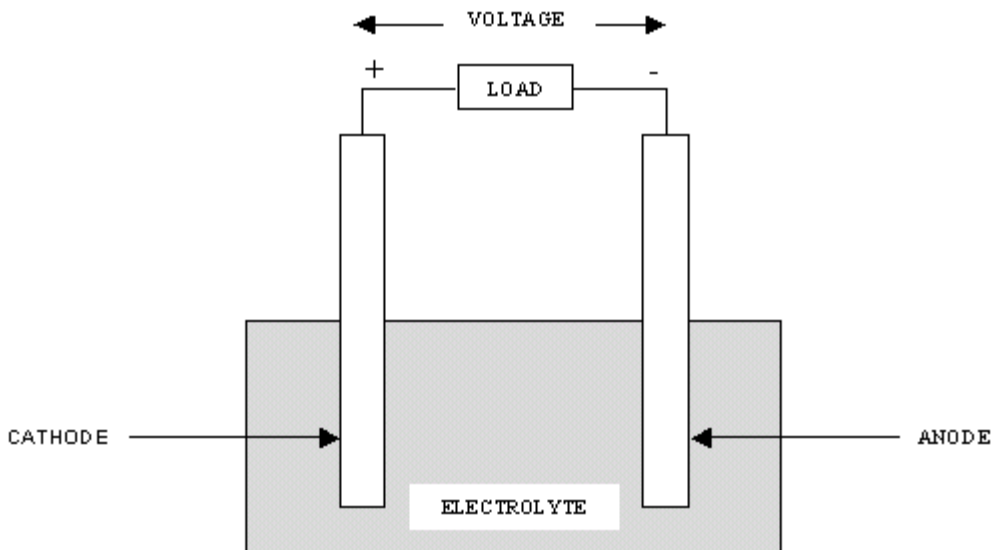

Figure 1: Components of a Cell

Considerations in selection of Cathode, Anode and Electrolyte

Desirable properties for anode, cathode, and electrolyte materials are noted below.

Anode material should exhibit the following properties

- Efficient reducing agent
- High *coulombic output*
- Good conductivity
- *Stable*
- Ease of fabrication
- Low cost
- Metals such as Zinc and Lithium are often used as anode materials.

Cathode material should exhibit the following properties

- Efficient oxidizing agent.
- Stable when in contact with electrolyte
- Useful *working voltage*
- Ease of fabrication
- Low cost
- Metallic oxides such as are often used as cathode materials

The most desirable anode-cathode material combinations are those that result in light-weight cells with high voltage and capacity. Such combinations may not always be practical as a result of extenuating factors such as material handling difficulty, reactivity with other cell components, difficulty of fabrication, *polarization* tendencies, and cost prohibitive materials.

Electrolytes should exhibit the following properties

- Strong ionic conductivity
- No electric conductivity
- Non-reactivity with electrode materials
- Properties resistance to temperature fluctuations
- Safeness in handling
- Low cost
- *Aqueous* solutions such as dissolved salts, acids, and alkalis are often used as electrolytes

The key function of a battery in a PV system is to provide power when other generating sources are unavailable, and hence batteries in PV systems will experience continual charging and discharging cycles. All battery parameters are affected by battery charging and recharging cycle.

Battery State of Charge (BSOC)

A key parameter of a battery in use in a PV system is the battery state of charge (BSOC). The BSOC is defined as the fraction of the total energy or battery capacity (INCLUDE LINK HERE) that has been used over the total available from the battery.

Battery state of charge (BSOC or SOC) gives the ratio of the amount of energy presently stored in the battery to the nominal rated capacity. For example, for a battery at 80% SOC and with a 500 Ah capacity, the energy stored in the battery is 400 Ah. A common way to measure the BSOC is to measure the voltage of the battery and compare this to the voltage of a fully charged battery. However, as the battery voltage depends on temperature as well the state of charge of the battery, this measurement provides only a rough idea of battery state of charge.

Depth of Discharge

In many types of batteries, the full energy stored in the battery cannot be withdrawn (in other words, the battery cannot be fully discharged) without causing serious, and often irreparable damage to the battery. The Depth of Discharge (DOD) of a battery determines the fraction of power that can be withdrawn from the battery. For example, if the DOD of a battery is given by the manufacturer as 25%, then only 25% of the battery capacity can be used by the load.

Nearly all batteries, particularly for renewable energy applications, are rated in terms of their capacity. However, the actual energy that can be extracted from the battery is often (particularly for lead acid batteries) significantly less than the rated capacity. This occurs since, particularly for lead acid batteries, extracting the full battery capacity from the battery dramatically reduced battery lifetime. The depth of discharge (DOD) is the fraction of battery capacity that can be used from the battery and will be specified by the manufacturer. For example, a battery 500 Ah with a DOD of 20% can only provide $500\text{Ah} \times .2 = 100\text{ Ah}$.

Daily Depth of Discharge

In addition to specifying the overall depth of discharge, a battery manufacturer will also typically specify a daily depth of discharge. The daily depth of discharge determined the maximum amount of energy that can be extracted from the battery in a 24 hour period. Typically in a larger scale PV system (such as that for a remote house), the battery bank is inherently sized such that the daily depth of discharge is not an additional constraint. However, in smaller systems that have relatively few days storage, the daily depth of discharge may need to be calculated.

Charging and Discharging Rates

A common way of specifying battery capacity is to provide the battery capacity as a function of the time in which it takes to fully discharge the battery (note that in practice the battery often cannot be fully discharged). The notation to specify battery capacity in this way is written as C_x , where x is the time in hours that it takes to discharge the battery. In the above table, $C_{10} = xxx$ (also written as $C_{10} = xxx$) means that the battery capacity is xxx when the battery is discharged in 10 hours. When the discharging rate is halved (and the time it takes to discharge the battery is doubled to 20 hours), the battery capacity rises to xxx . The discharge rate when discharging the battery in 10 hours is found by dividing the capacity by the time. Therefore, $C/10$ is the charge rate. This may also be written as $0.1C$. Consequently, a specification of $C_{20}/10$ (also written as $0.1C_{20}$) is the charge rate obtained when the battery capacity (measured when the battery is discharged in 20 hours) is

discharged in 10 hours. Such relatively complicated notations may result when higher or lower charging rates are used for short periods of time.

Battery Performance Characteristics

Specifications, Standards and Hype

Batteries may be advertised as Long Life, High Capacity, High Energy, Deep Cycle, Heavy Duty, Fast Charge, Quick Charge, Ultra and other, ill defined, parameters and there are few industry or legal standards defining exactly what each of these terms means. Advertising words can mean whatever the seller wants them to mean. Apart from the basic battery design, performance actually depends on how the batteries are used and also on the environmental conditions under which they are used, but these conditions are rarely, if ever, specified in mass market advertising. For the consumer this can be very confusing or misleading. The battery industry itself however does not use such vague terms to specify battery performance and specifications normally include a statement defining or limiting the operating or environmental conditions within which the claimed performance can be delivered.

The following section outlines key parameters used to characterise the cells or batteries and shows how these parameters may vary with the operating conditions.

Discharge Curves

Energy cells have been developed for a wide range of applications using a variety of different technologies, resulting in a wide range of available performance characteristics. The graphs below show some of the main factors an applications engineer should take into account when specifying a battery to match the performance requirements of the end product.

Cell Chemistry

The nominal voltage of a galvanic cell is fixed by the electrochemical characteristics of the active chemicals used in the cell, the so called cell chemistry. The actual voltage appearing at the terminals at any particular time, as with any cell, depends on the load current and the internal impedance of the cell and this varies with, temperature, the state of charge and with the age of the cell.

The graph below shows typical discharge curves for cells using a range of cell chemistries when discharged at 0.2C rate. Note that each cell chemistry has its own characteristic nominal voltage and discharge curve. Some chemistries such as Lithium Ion have a fairly flat discharge curve while others such as Lead acid have a pronounced slope.

The power delivered by cells with a sloping discharge curve falls progressively throughout the discharge cycle. This could give rise to problems for high power applications towards the end of the cycle. For low power applications which need a stable supply voltage, it may be necessary to incorporate a voltage regulator if the slope is too steep. This is not usually an option for high power applications since the losses in the regulator would rob even more power from the battery.

A flat discharge curve simplifies the design of the application in which the battery is used since the supply voltage stays reasonably constant throughout the discharge cycle. A sloping curve facilitates the estimation of the State of Charge of the battery since the cell voltage can be used as a measure of the remaining charge in the cell. Modern Lithium Ion cells have a very flat discharge curve and other methods must be used to determine the State of Charge

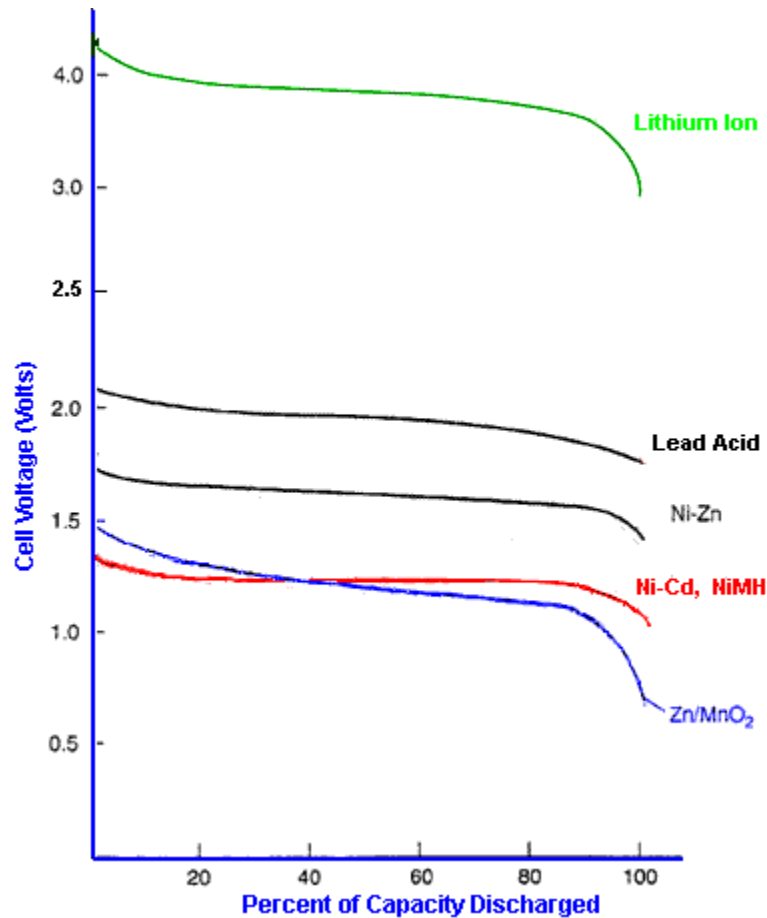

The X axis shows the cell characteristics normalised as a percentage of cell capacity so that the shape of the graph can be shown independent of the actual cell capacity. If the X axis was based on discharge time, the length of each discharge curve would be proportional to the nominal capacity of the cell.

Temperature Characteristics

Cell performance can change dramatically with temperature. At the lower extreme, in batteries with aqueous electrolytes, the electrolyte itself may freeze setting a lower limit on the operating temperature. At low temperatures Lithium batteries suffer from Lithium plating of the anode causing a permanent reduction in capacity. At the upper extreme the active chemicals may break down destroying the battery. In between these limits the cell performance generally improves with temperature. See also Thermal Management and Battery Life for more details.

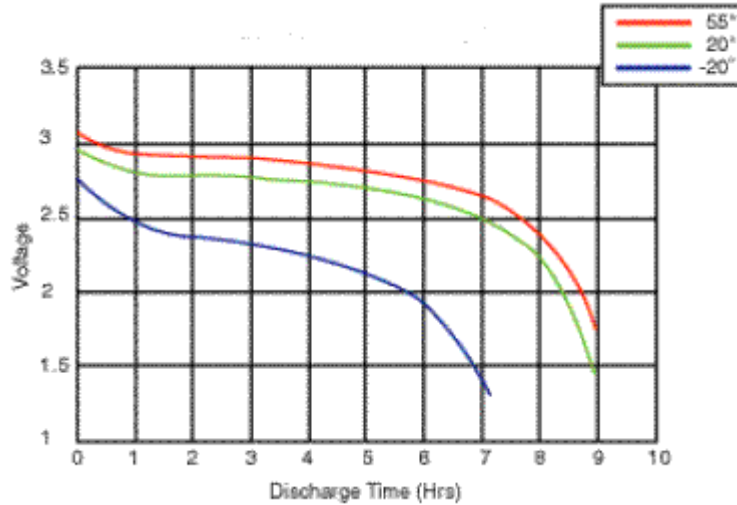

The above graph shows how the performance of Lithium Ion batteries deteriorates as the operating temperature decreases.

Probably more important is that, for both high and low temperatures, the further the operating temperature is from room temperature the more the cycle life is degraded. See Lithium Battery Failures.

Self Discharge Characteristics

The self discharge rate is a measure of how quickly a cell will lose its energy while sitting on the shelf due to unwanted chemical actions within the cell. The rate depends on the cell chemistry and the temperature.

Cell Chemistry

The following shows the typical shelf life for some primary cells:

- Zinc Carbon (Leclanché) 2 to 3 years
- Alkaline 5 years
- Lithium 10 years or more

Typical self discharge rates for common rechargeable cells are as follows:

- Lead Acid 4% to 6% per month
- Nickel Cadmium 15% to 20% per month
- Nickel Metal Hydride 30% per month
- Lithium 2% to 3% per month

Temperature Effects

The rate of unwanted chemical reactions which cause internal current leakage between the positive and negative electrodes of the cell, like all chemical reactions, increases with temperature thus increasing the battery self discharge rate. See also Battery Life . The graph below shows typical self discharge rates for a Lithium Ion battery.

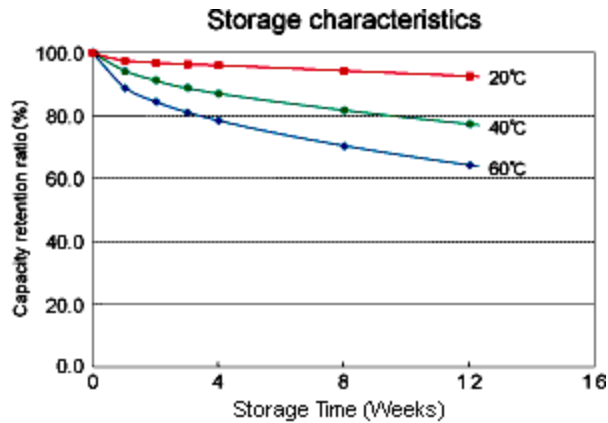

Internal Impedance

The internal impedance of a cell determines its current carrying capability. A low internal resistance allows high currents.

Battery Equivalent Circuit

The diagram on the right shows the equivalent circuit for an energy cell.

- R_m is the resistance of the metallic path through the cell including the terminals, electrodes and inter-connections.
- R_a is the resistance of the electrochemical path including the electrolyte and the separator.
- C_b is the capacitance of the parallel plates which form the electrodes of the cell.
- R_i is the non-linear contact resistance between the plate or electrode and the electrolyte.

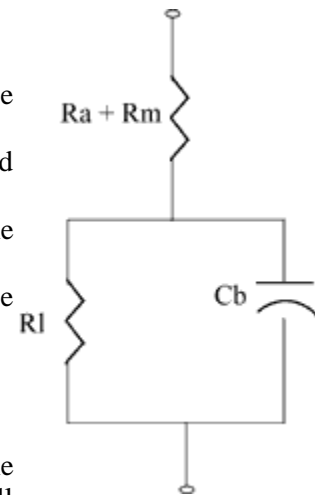

Typical internal resistance is in the order of milliohms.

Effects of Internal Impedance

When current flows through the cell there is an IR voltage drop across the internal resistance of the cell which decreases the terminal voltage of the cell during discharge and increases the voltage needed to charge the cell thus reducing its effective capacity as well as decreasing its charge/discharge efficiency. Higher discharge rates give rise to higher internal voltage drops which explains the lower voltage discharge curves at high C rates. See "Discharge Rates" below.

The internal impedance is affected by the physical characteristics of the electrolyte, the smaller the granular size of the electrolyte material the lower the impedance. The grain size is controlled by the cell manufacturer in a milling process.

Spiral construction of the electrodes is often used to maximise the surface area and thus reduce internal impedance. This reduces heat generation and permits faster charge and discharge rates.

The internal resistance of a galvanic cell is temperature dependent, decreasing as the temperature rises due to the increase in electron mobility. The graph below is a typical example.

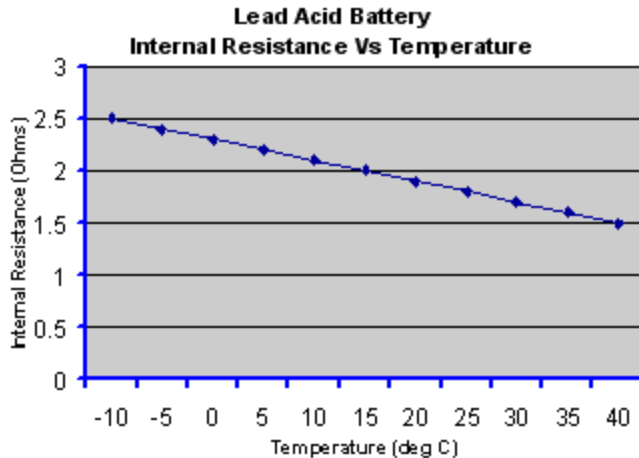

Thus the cell may be very inefficient at low temperatures but the efficiency improves at higher temperatures due to the lower internal impedance, but also to the increased rate of the chemical reactions. However the lower internal resistance unfortunately also causes the self discharge rate to increase. Furthermore, cycle life deteriorates at high temperatures. Some form of heating and cooling may be required to maintain the cell within a restricted temperature range to achieve the optimum performance in high power applications.

The internal resistance of most cell chemistries also tends to increase significantly towards the end of the discharge cycle as the active chemicals are converted to their discharged state and hence are effectively used up. This is principally responsible for the rapid drop off in cell voltage at the end of the discharge cycle.

In addition the Joule heating effect of the I^2R losses in the internal resistance of the cell will cause the temperature of the cell to rise.

The voltage drop and the I^2R losses may not be significant for a 1000 mAh cell powering a mobile phone but for a 100 cell 200 Ah automotive battery they can be substantial. Typical internal resistance for a 1000mA Lithium mobile phone battery is around 100 to 200mOhm and around 1mOhm for a 200Ah Lithium cell used in an automotive battery. See example.

Operating at the C rate the voltage drop per cell will be about 0.2 volts in both cases, (slightly less for the mobile phone). The I^2R loss in the mobile phone will be between 0.1 and 0.2 Watts. In the automotive battery however the voltage drop across the whole battery will be 20 Volts and I^2R power loss dissipated as heat within the battery will be 40 Watts per cell or 4KW for the whole battery. This is in addition to the heat generated by the electrochemical reactions in the cells.

As a cell ages, the resistance of the electrolyte tends to increase. Aging also causes the surface of the electrodes to deteriorate and the contact resistance builds up and at the same the effective area of the plates decreases reducing its capacitance. All of these effects increase the internal impedance of the cell adversely affecting its ability to perform. Comparing the actual impedance of a cell with its impedance when it was new can be used to give a measure or representation of the age of a cell or its effective capacity. Such measurements are much more convenient than actually discharging the cell and can be taken without destroying the cell under test. See "Impedance and Conductance Testing"

The internal resistance also influences the effective capacity of a cell. The higher the internal resistance, the higher the losses while charging and discharging, especially at higher currents. This means that for high discharge rates the lower the available capacity of the cell. Conversely, if it is discharged over a

prolonged period, the AmpHour capacity is higher. This is important because some manufacturers specify the capacity of their batteries at very low discharge rates which makes them look a lot better than they really are.

Discharge Rates

The discharge curves for a Lithium Ion cell below show that the effective capacity of the cell is reduced if the cell is discharged at very high rates (or conversely increased with low discharge rates). This is called the capacity offset and the effect is common to most cell chemistries.

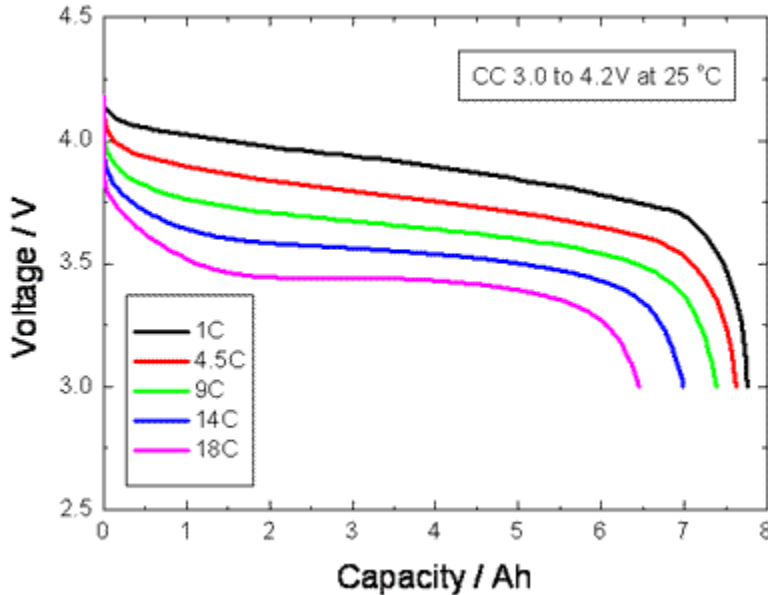

Battery Load

Battery discharge performance depends on the load the battery has to supply.

If the discharge takes place over a long period of several hours as with some high rate applications such as electric vehicles, the effective capacity of the battery can be as much as double the specified capacity at the C rate. This can be most important when dimensioning an expensive battery for high power use. The capacity of low power, consumer electronics batteries is normally specified for discharge at the C rate whereas the SAE uses the discharge over a period of 20 hours (0.05C) as the standard condition for measuring the Amp-hour capacity of automotive batteries. The graph below shows that the effective capacity of a deep discharge lead acid battery is almost doubled as the discharge rate is reduced from 1.0C to 0.05C. For discharge times less than one hour (High C rates) the effective capacity falls off dramatically.

The effectiveness of charging is similarly influenced by the rate of charge. An explanation of the reasons for this is given in the section on Charging Times .

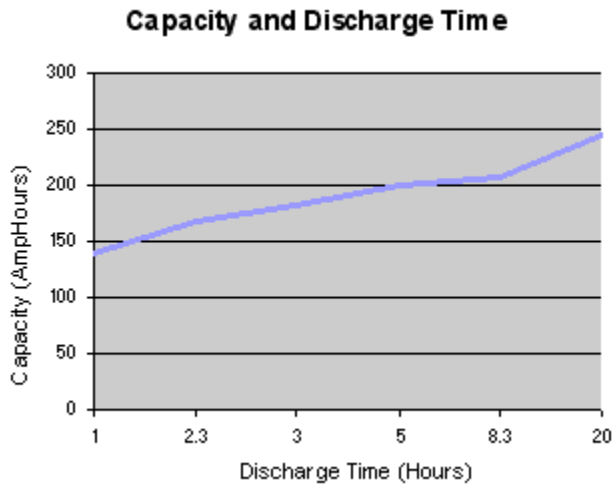

There are two conclusions to be drawn from this graph:

- Care should be exercised when comparing battery capacity specifications to ensure that comparable discharge rates are used.
- In an automotive application, if high current rates are used regularly for hard acceleration or for hill climbing, the range of the vehicle will be reduced.

Duty Cycle

Duty cycles are different for each application. EV and HEV applications impose particular, variable loads on the battery. See Load Testing example. Stationary batteries used in distributed grid energy storage applications may have very large SOC changes and many cycles per day.

It is important to know how much energy is used per cycle and to design for the maximum energy throughput and power delivery, not the average.

Notes: For information

- A typical small electric car will use between 150 to 250 Watthours of energy per mile with normal driving. Thus, for a range of 100 miles at 200 Watthours per mile, a battery capacity of 20 KWh will be required.
- Hybrid electric vehicle use smaller batteries but they may be required to operate at very high discharge rates of up to 40C. If the vehicle uses regenerative braking the battery must also accept very high charging rates to be effective. See the section about Capacitors for an example of how this requirement can be accommodated.

Peukert Equation

The Peukert equation is a convenient way of characterising cell behaviour and of quantifying the capacity offset in mathematical terms.

This is an empirical formula which approximates how the available capacity of a battery changes according to the rate of discharge. $C = I^n T$ where "C" is the theoretical capacity of the battery expressed in amp hours, "I" is the current, "T" is time, and "n" is the Peukert Number, a constant for the given battery. The equation shows that at higher currents, there is less available energy in the battery. The Peukert Number is directly related to the internal resistance of the battery. Higher currents mean more losses and less available capacity.

The value of the Peukert number indicates how well a battery performs under continuous heavy currents. A value close to 1 indicates that the battery performs well; the higher the number, the more capacity is lost when the battery is discharged at high currents. The Peukert number of a battery is determined empirically. For Lead acid batteries the number is typically between 1.3 and 1.4

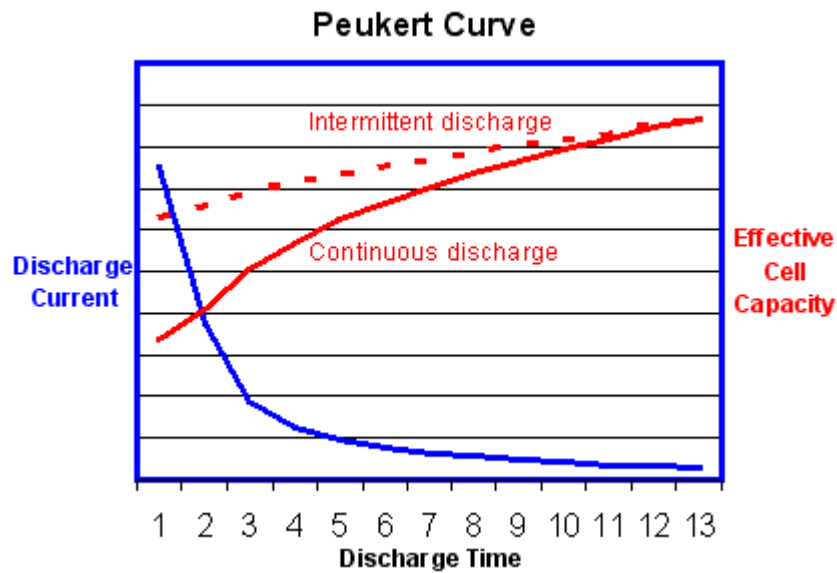

The graph above shows that the effective battery capacity is reduced at very high continuous discharge rates. However with intermittent use the battery has time to recover during quiescent periods when the temperature will also return towards the ambient level. Because of this potential for recovery, the capacity reduction is less and the operating efficiency is greater if the battery is used intermittently as shown by the dotted line.

This is the reverse of the behaviour of an internal combustion engine which operates most efficiently with continuous steady loads. In this respect electric power is a better solution for delivery vehicles which are subject to continuous interruptions.

Ragone Plots

The Ragone plot is useful for characterising the trade-off between effective capacity and power handling. Note that the Ragone plots are usually based on logarithmic scales.

The graph below shows the superior gravimetric energy density of Lithium Ion cells. Note also that Lithium ion cells with Lithium Titanate anodes (Altairnano) deliver a very high power density but a reduced energy density.

Energy and Power Density - Ragone Plot

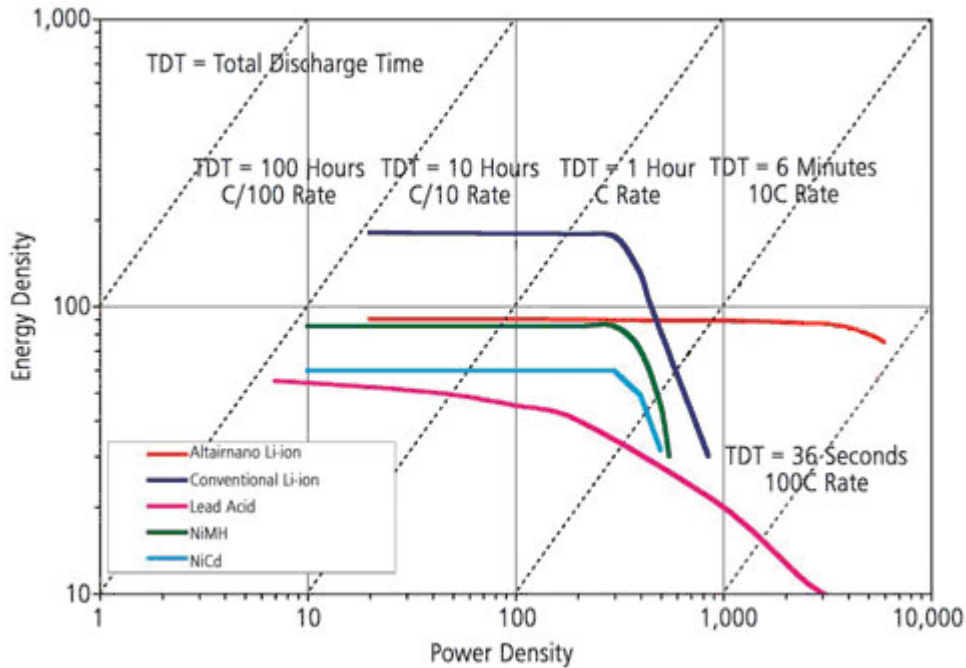

Source Altairnano

The Ragone plot below compares the performance of a range of electrochemical devices. It shows that ultracapacitors (supercapacitors) can deliver very high power but the storage capacity is very limited. On the other hand Fuel Cells can store large amounts of energy but have a relatively low power output.

Ragone Plot of Electrochemical Devices

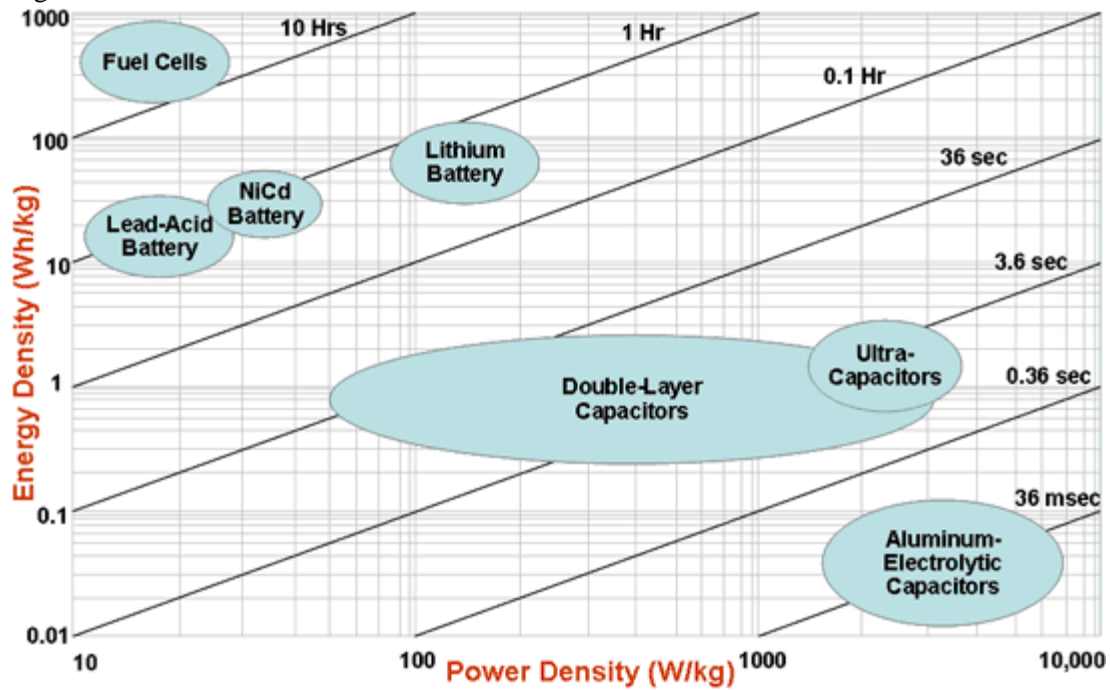

Source US Defence Logistics Agency

The sloping lines on the Ragone plots indicate the relative time to get the charge in or out of the device. At one extreme, power can be pumped into, or extracted from, capacitors in microseconds. This makes them ideal for capturing regenerative braking energy in EV applications. At the other extreme, fuel cells have a very poor dynamic performance taking hours to generate and deliver their energy. This limits their application in EV applications where they are often used in conjunction with batteries or capacitors to overcome this problem. Lithium batteries are somewhere in between and provide a reasonable compromise between the two.

Unit 3

DC & AC ELECTRICAL MACHINES

Motor and Engine rating

Electric Motor Power Rating

Similarly when we discuss about motor power rating, we are looking for the suitable conditions where maximum efficiency is obtained from the electric motor. When the motor have insufficient rating, there will be frequent damages and shut downs due to over loading, and this is not intended.

On the other hand, if the power rating of a motor is decided liberally, the extra initial cost and then loss of energy due to operation below rated power makes this choice totally uneconomical. Another essential criteria of electrical motor power rating is that, during operation of motor, heat is produced and it is inevitable due to I^2R loss in the circuit and friction within the motor. So, the ventilation system of the motor should be designed very carefully, to dissipate the generated heat as quickly as possible. The output power of the motor is directly related with the temperature rise, that's why it is also called thermal loading. The thermal dissipation will be ideal when the ventilation system is designed in such a way that the heat generated during the operation is equal to or less than heat dissipated by the motor to the surrounding. Now, due to the design of motors, temperature is not same everywhere inside the motor. There is a high amount of heat produced in the windings because, windings cause higher heat generation. The insulating materials used in the winding are also chosen depending on the amount of heat generated inside the motor during operation.

Requirements of Machines:

In order to achieve this objective the machine element should satisfy the following basic requirements

- 1) Strength
- 2) Rigidity
- 3) Wear resistance
- 4) Minimum dimensions and weights
- 5) Manufacturability

- 6) Safety
- 7) Conformance to standards
- 8) Reliability
- 9) Maintainability

Strength

A machine part should not fail under the effect of the forces that act up on it. It should have sufficient strength to avoid failure either due to fracture (or) due to general yielding.

Rigidity

A machine component should be rigid that is it should not deflect (or) bend too much due to the forces or moments that act up on it.

Wear resistance

Wear is the main reason that puts the machine parts out of order. It reduces the useful life of the component. There are different types of wear such as

- a. Abrasive wear
- b. Corrosive wear
- c. Pitting

Surface hardening can increase the wear resistance of the machine components such as gears and cams.

Minimum dimensions and weights

A machine part should be sufficiently strong rigid wear resistance and at the same time with minimum possible dimensions and weights

Manufacturability

The shape and material of the machine part should be selected in such a way that it can be produced with minimum labor cost.

Safety

The shape and dimensions of machine parts should ensure safety to the operator of machine.

Conformance to standards

A machine part should conform to the national standards covering its profile dimensions grade and material.

Reliability

It is the probability that a machine part will perform its intended function. Over a specified period of time that is it should perform its function over its life time.

Maintainability

It is the ease with which a machine part can be serviced or repaired. Minimum life cycle cost. It is the total cost to be paid by the purchaser for purchasing the part and operating it over its life time.

DC machines:

A DC motor in simple words is a device that converts electrical energy (direct current system) into mechanical energy. It is of vital importance for the industry today, and is equally important for engineers to look into the working principle of DC motor in details that has been discussed in this article. In order to understand the operating principle of DC motor we need to first look into its constructional feature. dc motor parts The very basic construction of a DC motor contains a current carrying armature which is connected to the supply end through commutator segments and brushes. The armature is placed in between north south poles of a permanent or an electromagnet as shown in the diagram above.

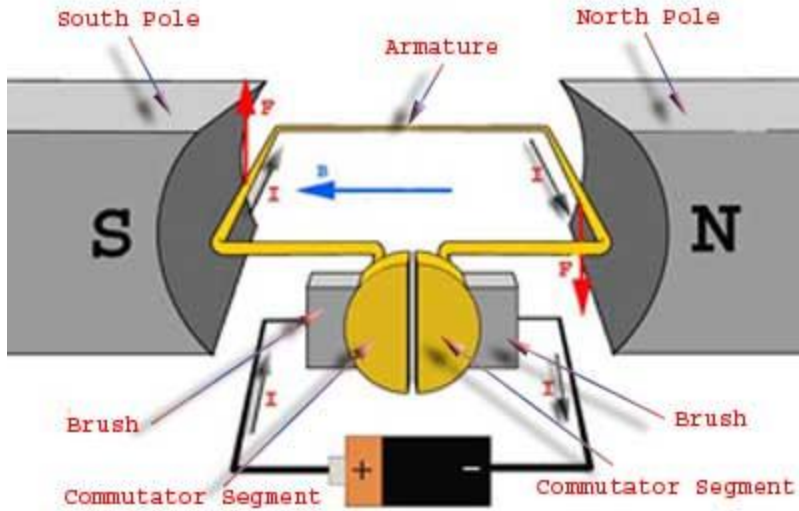

we have to determine the magnitude of the force, by considering the diagram below.

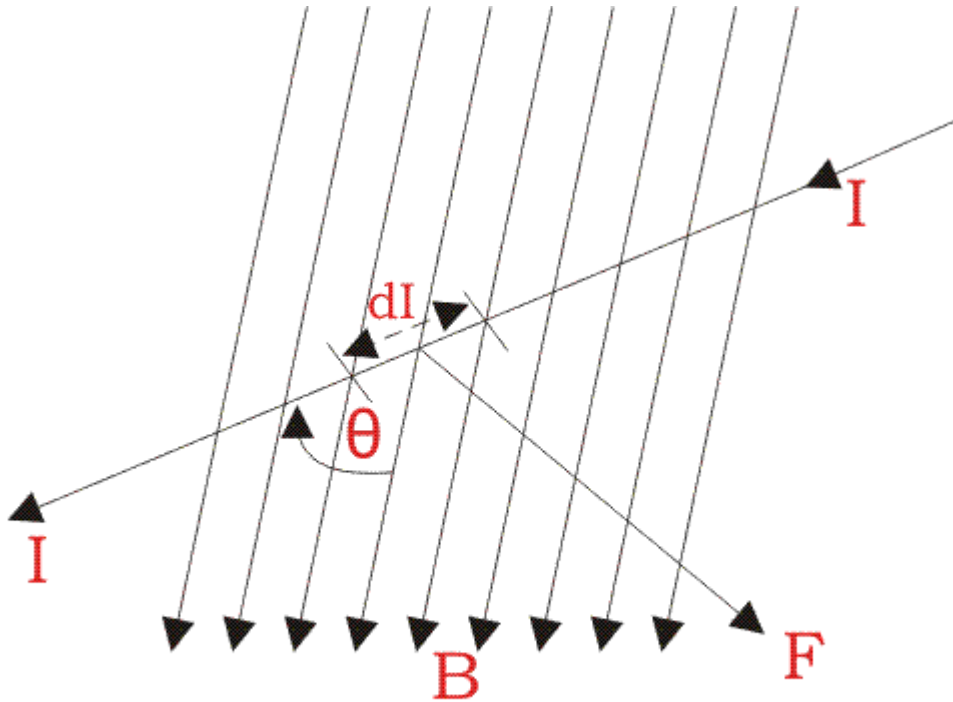

We know that when an infinitely small charge dq is made to flow at a velocity ' v ' under the influence of an electric field E , and a magnetic field B , then the Lorentz Force dF experienced by the charge is given by:- For the operation of DC motor, considering $E = 0$ i.e. it's the cross product of $dq v$ and magnetic field B . Where, dL is the length of the conductor carrying charge q . From the 1st diagram we can see that the construction of a DC motor is such that the direction of current through the armature conductor at all instance is perpendicular to the field. Hence the force acts on the armature conductor in the direction perpendicular to the both uniform field and current is

constant. So if we take the current in the left hand side of the armature conductor to be I , and current at right hand side of the armature conductor to be $-I$, because they are flowing in the opposite direction with respect to each other.

Then the force on the left hand side armature conductor, Similarly force on the right hand side conductor. Therefore, we can see that at that position the force on either side is equal in magnitude but opposite in direction. And since the two conductors are separated by some distance w = width of the armature turn, the two opposite forces produces a rotational force or a torque that results in the rotation of the armature conductor.

Now let's examine the expression of torque when the armature turn crate an angle of α (alpha) with its initial position.

The torque produced is given by, Where, α (alpha) is the angle between the plane of the armature turn and the plane of reference or the initial position of the armature which is here along the direction of magnetic field.

The presence of the term $\cos\alpha$ in the torque equation very well signifies that unlike force the torque at all position is not the same. It in fact varies with the variation of the angle α (alpha). To explain the variation of torque and the principle behind rotation of the motor let us do a step wise analysis.

Three phase A/c Machines:

1. Aluminum-alloy frame is strong with light weight.

Aluminum-alloy(used in the manufacturing of airplane, Shinkansen train, etc.) is used for raw material of housing, which makes the motor to effectively ventilate heat and provides light weight.

2. The insulated lead wire has high performance and efficiency.

With our long history, we have developed high quality insulated lead wire and Wanis, that can support various hostile environments, even with very high temperature.

3. Special Slot and Compact Coil make the motor quiet with high performance.

From the start to running, it can smoothly start with high performance, which reduces the damage of machine because of low vibration. The motor does not harm the environment and the machine.

4. Bearing has high performance with the use of Grease for heat resistance.

We use high quality Grease for lubrication, which can be used effectively in low or high temperature because of the shield bearing.

5. Liquid Gasket Seal (for IP55)

We use high quality liquid seal for IP55 motor, which sustain high durable and longlife.

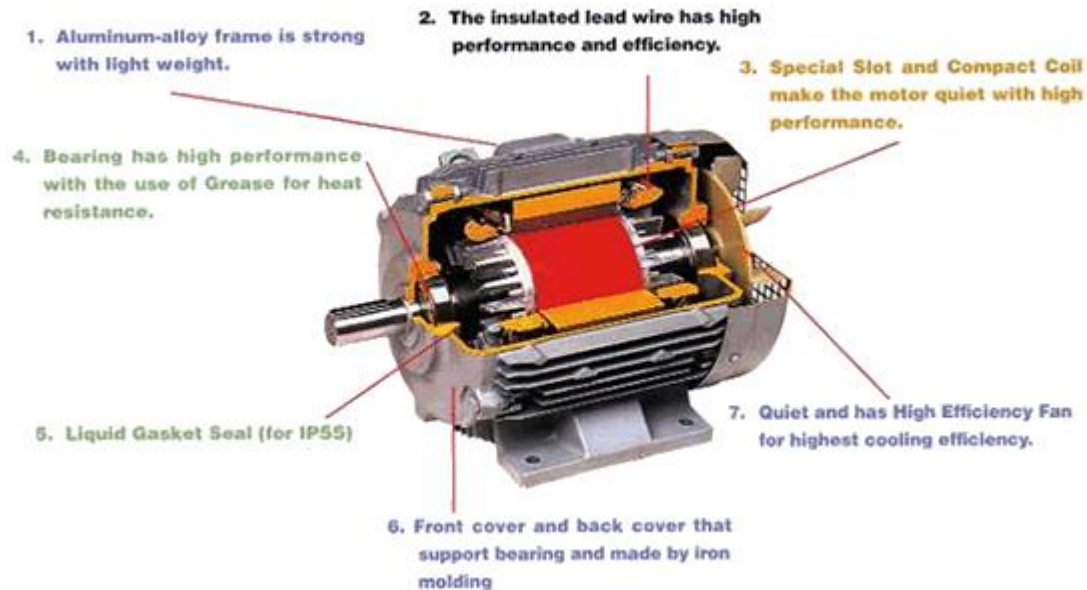

6. Front cover and back cover that support bearing and made by iron molding

Bearing maintains its optimal performance through usage life, of which its structure is recognized by our customers as the most reliable motor. As a result of our long research and experience, we have discovered and manufactured high-quality motors, which sustain low vibration and could tolerate vibration very nicely.

7. Quiet and has High Efficiency Fan for highest cooling efficiency.

The ventilation process is developed from CAE(Computer Aided Engineering) and has high efficiency fan with quietness. This high quality motor is accomplished through the effective use aluminum alloy.

Induction machines.

Induction Motor Action

Induction motors use shorted wire loops on a rotating armature and obtain their torque from currents induced in these loops by the changing magnetic field produced in the stator (stationary) coils.

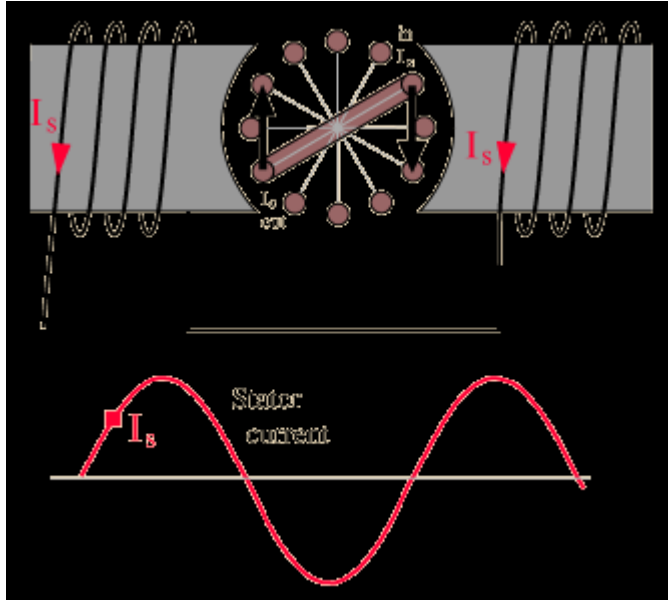

At the moment illustrated, the current in the stator coil is in the direction shown and increasing. The induced voltage in the coil shown drives current and results in a clockwise torque.

Note that this simplified motor will turn once it is started in motion, but has no starting torque. Various techniques are used to produce some asymmetry in the fields to give the motor a starting torque.

Permanent magnet machines:

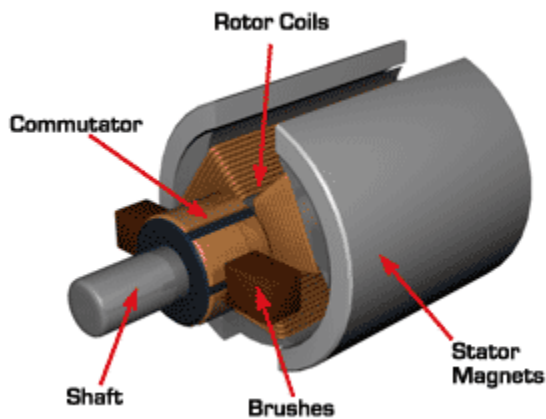

In a DC motor, an armature rotates inside a magnetic field. Basic working principle of DC motor is based on the fact that whenever a current carrying conductor is placed inside a magnetic field, there will be mechanical force experienced by that conductor.

All kinds of DC motors work in this principle only. Hence for constructing a DC motor it is essential to establish a magnetic field. The magnetic field is obviously established by means of magnet. The magnet can be any type i.e. it may be electromagnet or it can be permanent magnet. When permanent magnet is used to create magnetic field in a DC motor, the motor is referred as permanent magnet DC motor or PMDC motor. Have you ever uncovered any battery operated toy, if you did, you had obviously found a battery operated motor inside it. This battery operated motor is nothing but a permanent magnet DC motor or PMDC motor. These types of motor are essentially simple in construction. These motors are commonly used as starter motor in automobiles, windshield wipers, washer, for blowers used in heaters and air conditioners, to raise and lower windows, it is also extensively used in toys. As the magnetic field strength of a permanent magnet is fixed it cannot be controlled externally, field control of this type of DC motor cannot be possible. Thus permanent magnet DC motor is used where there is no need of speed control of motor by means of controlling its field. Small fractional and sub fractional KW motors are now constructed with permanent magnet.

Switched Reluctance motor:

Construction of SRM

Construction details of switched reluctance motor with six stator poles and four rotor poles can be explained by referring to figure 3.1

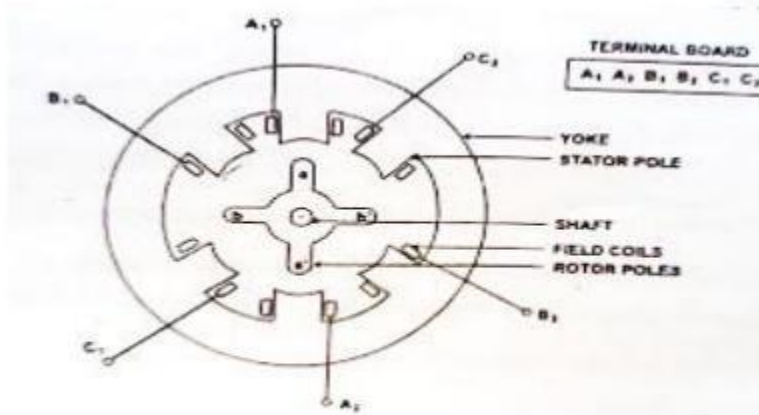

Fig 3.1 Cross sectional view of SRM

The stator is made up of silicon steel stampings with inward projected poles. The number of poles. The number of poles of the stator can be either an even number or an odd number. Most of the motors available have even number of stator poles (6 or 8). All these poles carry field coils. The field coils of opposite poles are connected in series such that their mmf's are additive and they are called phase windings. Individual coil or a group of coils constitute phase windings. Each of the phase windings are connected to the terminal of the motor. These terminals are suitably connected to the output terminals of a power semiconductor switching circuitry, whose input is a d.c. supply.

Block Diagram Of SRM

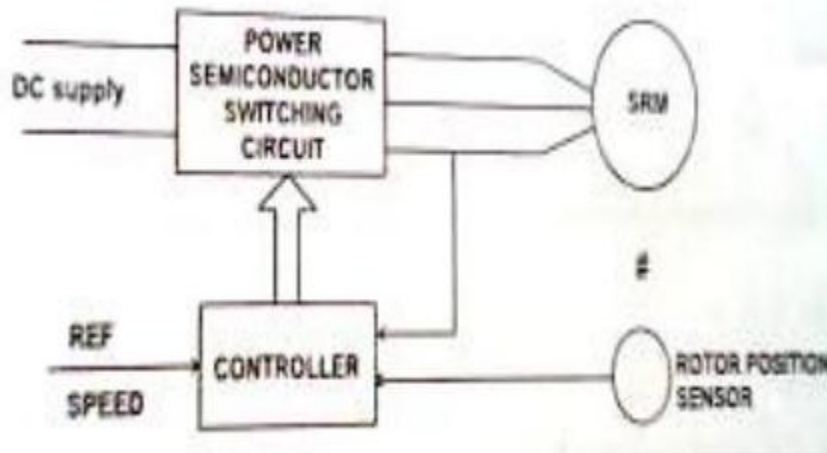

Fig. 3.2 Block Diagram Of SRM

Fig. 3.2 shows the block diagram of SRM. Dc supply is given to the power semiconductor switching circuitry which is connected to various phase windings of SRM. Rotor position sensor which is mounted on the shaft of SRM, provides signals to the controller about the position of the rotor with reference to reference axis. Controller collects this information and also the reference speed signal and suitably turns ON and OFF the concerned power semiconductor device to the dc supply. The current signal is also fed back to the controller to limit the current within permissible limits.

TRANSMISSION CONFIGURATION

Manual transmission

A manual transmission, also known as a manual gearbox, stick shift, n -speed manual (where n is its number of forward gear ratios), standard, MT, or in colloquial U.S. English, a stick (for vehicles with hand-lever shifters), is a type of transmission used in motor vehicle applications. It uses a driver-operated clutch engaged and disengaged by a foot pedal (automobile) or hand lever (motorcycle), for regulating torque transfer from the engine to the transmission; and a gear selector operated by hand (automobile) or by foot (motorcycle).

A conventional 5-speed manual transmission is often the standard equipment in a base-model car, while more expensive manual vehicles are usually equipped with a 6-speed transmission instead; other options include automatic transmissions such as a traditional automatic (hydraulic planetary) transmission (often a manumatic), a semi-automatic transmission, or a continuously variable transmission (CVT). The number of forward gear ratios is often expressed for automatic transmissions as well (e.g., 9-speed automatic).

Overview[edit]

Manual transmissions often feature a driver-operated clutch and a movable gear stick. Most automobile manual transmissions allow the driver to select any forward gear ratio ("gear") at any time, but some, such as those commonly mounted on motorcycles and some types of racing cars, only allow the driver to select the next-higher or next-lower gear. This type of transmission is sometimes called a sequential manual transmission.

In a manual transmission, the flywheel is attached to the engine's crankshaft and spins along with it. The clutch disk is in between the pressure plate and the flywheel, and is held against the flywheel under pressure from the pressure plate. When the engine is running and the clutch is engaged (i.e., clutch pedal up), the flywheel spins the clutch plate and hence the transmission. As the clutch pedal is depressed, the throw out bearing is activated, which causes the pressure plate to stop applying pressure to the clutch disk. This makes the clutch plate stop receiving power from the engine, so that the gear can be shifted without damaging the transmission. When the clutch pedal is released, the throw out bearing is deactivated, and the clutch disk is again held against the flywheel, allowing it to start receiving power from the engine.

Manual transmissions are characterized by gear ratios that are selectable by locking selected gear pairs to the output shaft inside the transmission. Conversely, most automatic transmissions feature epicyclic (planetary) gearing controlled by brake bands and/or clutch packs to select gear ratio. Automatic transmissions that allow the driver to manually select the current gear are called manumatics. A manual-style transmission operated by computer is often called an *automated* transmission rather than an *automatic*, even though no distinction between the two terms need be made.

Contemporary automobile manual transmissions typically use four to six forward gear ratios and one reverse gear, although consumer automobile manual transmissions have been built with as few as two and as many as seven gears. Transmissions for heavy trucks and other heavy equipment usually have 8 to 25 gears so the transmission can offer both a wide range of gears and close gear ratios to keep the engine running in the power band. Operating aforementioned transmissions often use the same pattern of shifter movement with a single or multiple switches to engage the next sequence of gear selection.

Main article: Non-synchronous transmission

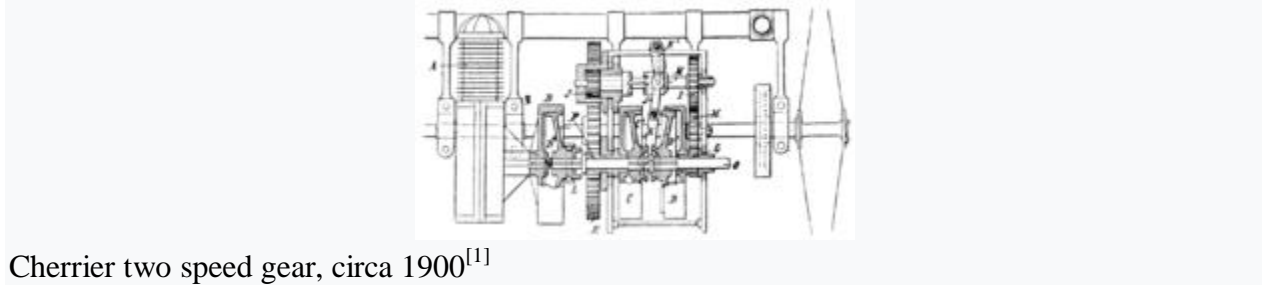

Cherrier two speed gear, circa 1900^[1]

The earliest form of a manual transmission is thought^[by whom?] to have been invented by Joe Clulow and Émile Levassor in the late 19th century. This type of transmission offered multiple gear ratios and, in most cases, reverse. The gears were typically engaged by sliding them on their shafts (hence the phrase *shifting gears*), which required careful timing and throttle manipulation when shifting, so the gears would be spinning at roughly the same speed when engaged; otherwise, the teeth would refuse to mesh. These transmissions are called *sliding mesh* transmissions or sometimes crash boxes, because of the difficulty in changing gears and the loud grinding sound that often accompanied. Newer manual transmissions on cars have all gears mesh at all times and are referred to as *constant-mesh* transmissions, with "synchro-mesh" being a further refinement of the constant mesh principle.

In both types, a particular gear combination can only be engaged when the two parts to engage (either gears or clutches) are at the same speed. To shift to a higher gear, the transmission is put in neutral and the engine allowed to slow down until the transmission parts for the next gear are at a proper speed to engage. The vehicle also slows while in neutral and that slows other transmission parts, so the time in neutral depends on the grade, wind, and other such factors. To shift to a lower gear, the transmission is put in neutral and the throttle is used to speed up the engine and thus the relevant transmission parts, to match speeds for engaging the next lower gear. For both upshifts and downshifts, the clutch is released (engaged) while in neutral. Some drivers use the clutch only for starting from a stop, and shifts are done without the clutch. Other drivers will depress (disengage) the clutch, shift to neutral, then engage the clutch momentarily to force transmission parts to match the engine speed, then depress the clutch again to shift to the next gear, a process called double clutching. Double clutching is easier to get smooth, as speeds that are close but not quite matched need to speed up or slow down only transmission parts, whereas with the clutch engaged to the engine, mismatched speeds are fighting the rotational inertia and power of the engine.

Even though automobile and light truck transmissions are now almost universally synchronized, transmissions for heavy trucks and machinery, motorcycles, and for dedicated racing are usually not. Non-synchronized transmission designs are used for several reasons. The friction material, such as brass, in synchronizers is more prone to wear and breakage than gears, which are forged steel, and the simplicity of the mechanism improves reliability and reduces cost. In addition, the process of shifting a synchromesh transmission is slower than that of shifting a non-synchromesh transmission. For racing of production-based transmissions, sometimes half the teeth on the dog clutches are removed to speed the shifting process, at the expense of greater wear.

Heavy duty trucks often use unsynchronized transmissions, though military trucks usually have synchronized transmissions, allowing untrained personnel to operate them in emergencies. In the United States, traffic safety rules refer to non-synchronous transmissions in classes of larger commercial motor vehicles. In Europe, heavy duty trucks use synchronized gearboxes as standard.

Similarly, most modern motorcycles use unsynchronized transmissions: their low gear inertias and higher strengths mean that forcing the gears to alter speed is not damaging, and the pedal operated selector on modern motorcycles, with no neutral position between gears (except, commonly, 1st and 2nd), is not conducive to having the long shift time of a synchronized gearbox. On bikes with a 1-N-2(-3-4...) transmission, it is necessary either to stop, slow down, or synchronize gear speeds by blipping the throttle when shifting from 2nd into 1st.

Synchronized transmission[edit]



Top and side view of a typical manual transmission, in this case a Ford Toploader, used in cars with external floor shifters.

Most modern manual-transmission vehicles are fitted with a synchronized gear box. Transmission gears are always in mesh and rotating, but gears on one shaft can freely rotate or be locked to the shaft. The locking mechanism for a gear consists of a collar (or *dog collar*) on the shaft which is able to slide sideways so that teeth (or *dogs*) on its inner surface bridge two circular rings with teeth on their outer circumference: one attached to the gear, one to the shaft hub. When the rings are bridged by the collar, that particular gear is rotationally locked to the shaft and determines the output speed of the transmission. The gearshift lever manipulates the collars using a set of linkages, so arranged so that one collar may be permitted to lock only one gear at any one time; when "shifting gears", the locking collar from one gear is disengaged before that of another is engaged. One collar often serves for two gears; sliding in one direction selects one transmission speed, in the other direction selects another.

In a synchromesh gearbox, to correctly match the speed of the gear to that of the shaft as the gear is engaged the collar initially applies a force to a cone-shaped brass clutch attached to the gear, which brings the speeds to match prior to the collar locking into place. The collar is prevented from bridging the locking rings when the speeds are mismatched by synchro rings (also called blocker rings or baulk rings, the latter being spelled *balk* in the U.S.). The synchro ring rotates slightly due to the frictional torque from the cone clutch. In this position, the dog clutch is prevented from engaging. The brass clutch ring gradually causes parts to spin at the same speed. When they do spin the same speed, there is no more torque from the cone clutch and the dog clutch is allowed to fall into engagement. In a modern gearbox, the action of all of these components is so smooth and fast it is hardly noticed.

The modern cone system was developed by Porsche and introduced in the 1952 Porsche 356; cone synchronisers were called *Porsche-type* for many years after this. In the early 1950s, only the second-third shift was synchromesh in most cars, requiring only a single synchro and a

simple linkage; drivers' manuals in cars suggested that if the driver needed to shift from second to first, it was best to come to a complete stop then shift into first and start up again. With continuing sophistication of mechanical development, fully synchromesh transmissions with three speeds, then four, and then five, became universal by the 1980s. Many modern manual transmission cars, especially sports cars, now offer six speeds. The 2012 Porsche 911 offers a seven-speed manual transmission, with the seventh gear intended for cruising- top speed being attained on sixth.

Reverse gear is usually not synchromesh, as there is only one reverse gear in the normal automotive transmission and changing gears into reverse while moving is not required—and often highly undesirable, particularly at high forward speed. Additionally, the usual method of providing reverse, with an idler gear sliding into place to bridge what would otherwise be two mismatched forward gears, is necessarily similar to the operation of a crash box. Among the cars that have synchromesh in reverse are the 1995–2000 Ford Contour and Mercury Mystique, '00–'05 Chevrolet Cavalier, Mercedes 190 2.3-16, the V6 equipped Alfa Romeo GTV/Spider (916),^[2] certain Chrysler, Jeep, and GM products which use the New Venture NV3500 and NV3550 units, the European Ford Sierra and Granada/Scorpio equipped with the MT75 gearbox, the Volvo 850, and almost all Lamborghinis, Hondas and BMWs.

Internals[edit]

Shafts[edit]

Like other transmissions, a manual transmission has several shafts with various gears and other components attached to them. Typically, a rear-wheel-drive transmission has three shafts: an input shaft, a *countershaft* and an output shaft. The countershaft is sometimes called a *layshaft*.

In a rear-wheel-drive transmission, the input and output shaft lie along the same line, and may in fact be combined into a single shaft within the transmission. This single shaft is called a *mainshaft*. The input and output ends of this combined shaft rotate independently, at different speeds, which is possible because one piece slides into a hollow bore in the other piece, where it is supported by a bearing. Sometimes the term *mainshaft* refers to just the input shaft or just the output shaft, rather than the entire assembly.

In many transmissions the input and output components of the mainshaft can be locked together to create a 1:1 gear ratio, causing the power flow to bypass the countershaft. The mainshaft then behaves like a single, solid shaft: a situation referred to as *direct drive*.

Even in transmissions that do not feature direct drive, it's an advantage for the input and output to lie along the same line, because this reduces the amount of torsion that the transmission case has to bear.

Under one possible design, the transmission's input shaft has just one pinion gear, which drives the countershaft. Along the countershaft are mounted gears of various sizes, which rotate when the input shaft rotates. These gears correspond to the forward speeds and reverse. Each of the forward gears on the countershaft is permanently meshed with a corresponding gear on the output shaft. However, these driven gears are not rigidly attached to the output shaft: although the shaft runs through them, they spin independently of it, which is made possible by bearings in their hubs. Reverse is typically implemented differently; see the section on Reverse.

Most front-wheel-drive transmissions for transverse engine mounting are designed differently. For one thing, they have an integral final drive and differential. For another, they usually have only two shafts; input and countershaft, sometimes called input and output. The input shaft runs

the whole length of the gearbox, and there is no separate input pinion. At the end of the second (counter/output) shaft is a pinion gear that mates with the ring gear on the differential.

Front-wheel and rear-wheel-drive transmissions operate similarly. When the transmission is put in neutral and the clutch is disengaged, the input shaft, clutch disk and countershaft can continue to rotate under their own inertia. In this state, the engine, the input shaft and clutch, and the output shaft all rotate independently.

Dog clutch[edit]

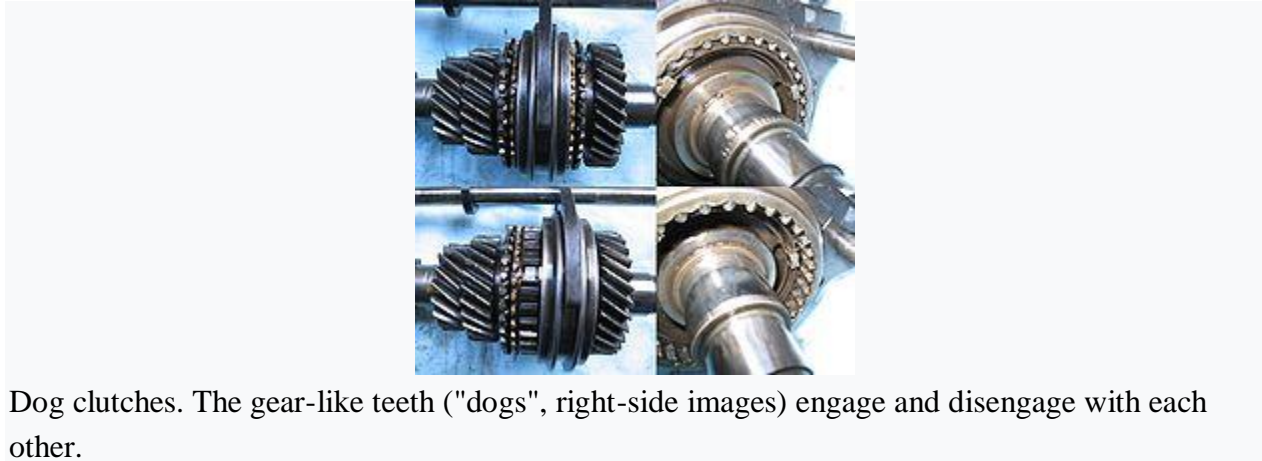

Dog clutches. The gear-like teeth ("dogs", right-side images) engage and disengage with each other.

Among many different types of clutches, a dog clutch provides non-slip coupling of two rotating members. It is not at all suited to intentional slipping, in contrast with the foot-operated friction clutch of a manual-transmission car.

The gear selector does not engage or disengage the actual gear teeth which are permanently meshed. Rather, the action of the gear selector is to lock one of the freely spinning gears to the shaft that runs through its hub. The shaft then spins together with that gear. The output shaft's speed relative to the countershaft is determined by the ratio of the two gears: the one permanently attached to the countershaft, and that gear's mate which is now locked to the output shaft.

Locking the output shaft with a gear is achieved by means of a dog clutch selector. The dog clutch is a sliding selector mechanism which is splined to the output shaft, meaning that its hub has teeth that fit into slots (splines) on the shaft, forcing that shaft to rotate with it. However, the splines allow the selector to move back and forth on the shaft, which happens when it is pushed by a selector fork that is linked to the gear lever. The fork does not rotate, so it is attached to a collar bearing on the selector. The selector is typically symmetric: it slides between two gears and has a synchromesh and teeth on each side in order to lock either gear to the shaft.

Synchromesh[edit]



Synchronizer rings

Synchromesh transmission was introduced by Cadillac in 1928.^[3] If the dog teeth make contact with the gear, but the two parts are spinning at different speeds, the teeth will fail to engage and a loud grinding sound will be heard as they clatter together. For this reason, a modern dog clutch in an automobile has a synchronizer mechanism or *synchromesh*, which consists of a cone clutch and blocking ring. Before the teeth can engage, the cone clutch engages first, which brings the selector and gear to the same speed using friction. Until synchronization occurs, the teeth are prevented from making contact, because further motion of the selector is prevented by a *blocker* (or *baulk*) ring. When synchronization occurs, friction on the blocker ring is relieved and it twists slightly, bringing into alignment certain grooves or notches that allow further passage of the selector which brings the teeth together. The exact design of the synchronizer varies among manufacturers.

The synchronizer^[4] has to overcome the momentum of the entire input shaft and clutch disk when it is changing shaft rpm to match the new gear ratio. It can be abused by exposure to the momentum and power of the engine, which is what happens when attempts are made to select a gear without fully disengaging the clutch. This causes extra wear on the rings and sleeves, reducing their service life. When an experimenting driver tries to "match the revs" on a synchronized transmission and force it into gear without using the clutch, the synchronizer will make up for any discrepancy in RPM. The success in engaging the gear without clutching can deceive the driver into thinking that the RPM of the layshaft and transmission were actually exactly matched. Nevertheless, approximate rev. matching *with clutching* can decrease the difference in rotational speed between the layshaft and transmission gear shaft, therefore decreasing synchro wear.

Synchronizing rings are made of metal and can be provided with anti-wear coatings called a friction lining. Common metals for synchronizer rings are brass and steel. The linings typically consist of molybdenum, iron, bronze or carbon. The synchronizing rings are produced either by massive forming (common forging) or sheet metal shaping. The latter involves the stamping of the blank out of a sheet metal strip and the subsequent machining with follow-on composite tools or transfer tools. A friction lining usually consists of thermally splashed molybdenum. Alternatively, iron or bronze sinter friction layers can be used. Carbon-coated synchronizer rings are particularly wear resistant and offer very good friction behavior. Due to their higher price, these are reserved for high-performance transmissions.^[5]

Transmissions with brass synchronizer components are generally not suitable for use with GL-5 specification oil unless specifically stated by the manufacturer as the extreme pressure (EP) additives in the oil are corrosive to brass and bronze components at high temperatures and

decrease the synchronizer effectiveness at low temperatures. The additives in GL-5 oil also cause physical damage to brass synchronizers as the EP additives bond more strongly to the brass than the brass does to itself, causing a small layer of brass to be worn off with every gear change.^{[6][7]} Instead, oil which meets only the GL-4 specification should be used whenever possible.

Reverse[edit]

The previous discussion normally applies only to the forward gears. The implementation of the reverse gear is usually different, implemented in the following way to reduce the cost of the transmission. Reverse is also a pair of gears: one gear on the countershaft and one on the output shaft. However, whereas all the forward gears are always meshed together, there is a gap between the reverse gears. Moreover, they are both attached to their shafts: neither one rotates freely about the shaft. When reverse is selected a small gear, called an *idler gear* or *reverse idler*, is slid between them. The idler has teeth which mesh with both gears, and thus it couples these gears together and reverses the direction of rotation without changing the gear ratio.

In other words, when reverse gear is selected, it is in fact *actual* gear teeth that are being meshed, with no aid from a synchronization mechanism. For this reason, the output shaft must not be rotating when reverse is selected: the car must be stopped. In order that reverse can be selected without grinding even if the input shaft is spinning inertially, there may be a mechanism to stop the input shaft from spinning. The driver brings the vehicle to a stop, and selects reverse. As that selection is made, some mechanism in the transmission stops the input shaft. Both gears are stopped and the idler can be inserted between them. There is a clear description of such a mechanism in the Honda Civic 1996–1998 Service Manual, which refers to it as a "noise reduction system":

Whenever the clutch pedal is depressed to shift into reverse, the mainshaft continues to rotate because of its inertia. The resulting speed difference between mainshaft and reverse idler gear produces gear noise [grinding]. The reverse gear noise reduction system employs a cam plate which was added to the reverse shift holder. When shifting into reverse, the 5th/reverse shift piece, connected to the shift lever, rotates the cam plate. This causes the 5th synchro set to stop the rotating mainshaft.

— (13-4)

A reverse gear implemented this way makes a loud whining sound, which is not normally heard in the forward gears. The teeth on the forward gears of most consumer automobiles are helically cut. When helical gears rotate, there is constant contact between gears, which results in quiet operation. In spite of all forward gears being always meshed, they do not make a sound that can be easily heard above the engine noise. By contrast, most reverse gears are spur gears, meaning that they have straight teeth, in order to allow for the sliding engagement of the idler, which is difficult with helical gears. The teeth of spur gears clatter together when the gears spin, generating a characteristic whine.

Attempting to select reverse while the vehicle is moving forward causes severe gear wear (except in transmissions with synchromesh on the reverse gear). However, most manual transmissions have a gate that locks out reverse directly from 5th gear to help prevent this. In order to engage reverse from 5th, the shift lever has to be moved to the center position between 3rd and 4th, then back over and into reverse. Another widespread solution places reverse to the left of 1st gear, instead of behind the 5th (where one might expect to find a 6th gear). Many newer six-speed manual transmissions have a collar under the shift knob which must be lifted to engage reverse. Other reverse lockout designs include having to push the shift lever inward, toward the floor, to

allow engagement of reverse, or requiring the driver to exert additional force to move the shift lever into reverse.

The spur gear design of reverse gear represents some compromises (less robust, unsynchronized engagement and loud noise) which are acceptable due to the relatively small amount of driving that takes place in reverse. The gearbox of the classic SAAB 900 is a notable example of a gearbox with a helical reverse gear engaged in the same unsynchronized manner as the spur gears described above. Its design allows reverse to share cogs with first gear, and is exceptionally quiet, but results in difficult engagement and unreliable operation. However, many modern transmissions now include a reverse gear synchronizer and helical gearing, especially in applications which use three shafts as part of the transmission implementation instead of the conventional dual input and output shafts (usually to permit a shorter gearbox for the number of gears provided), since the third shaft inherently provides the option to reverse output rotation while still allowing permanently meshing gears.

Design variations[edit]

Ratio count[edit]

Until the mid-1950s (earlier in Europe and later in the US, on average) cars were generally equipped with 3-speed transmissions as standard equipment. 4-speed units began to appear on volume-production models in the 1930s (Europe) and 1950s (USA) and gained popularity in the 1960s; some exotics had 5-speeds. In the 1970s, as fuel prices rose and fuel economy became an important selling feature, 4-speed transmissions with an overdrive 4th gear or 5-speeds were offered in mass market automobiles and even compact pickup trucks, pioneered by Toyota (who advertised the fact by giving each model the suffix *SR5* as it acquired the fifth speed). 6-speed transmissions started to emerge in high-performance vehicles in the early 1990s. 7-speed transmissions appeared on extreme high-end supercars, such as the 2005 Bugatti Veyron (semi-automatic manual transmission). In 2012, the Porsche 911 featured a 7-speed manual transmission, becoming the first of its class to support this feature, paving the way for the 2014 Chevrolet Corvette Stingray.

Today, mass market automotive manual transmissions are nearly all at least 5-speed. Four-speed manual transmission had fallen into almost total disuse by the end of the 1980s, having gradually become less common on cars during the 1980s. By the early 1990s, it was normally only found on cars with engines of around 1.0 litres.^[*citation needed*]

It has been widely anticipated that for electric vehicles (EVs), clutches and multi-speed gearboxes would not be required, as electric motors can drive the vehicle both forward and reverse from zero speed and typically operate over a wider speed range than combustion engines. Elimination of the gearbox represents a significant reduction in powertrain weight and complexity, and also removes a notable source of parasitic losses. The majority of first-generation consumer EVs have therefore been single-speed. However, current trends indicate that multi-speed gearboxes are likely to return for many future EVs. This allows the use of smaller, lower torque motors running at higher speeds to achieve both greater torque at the wheels for low speed tractive effort, and higher top road speed. Modest efficiency gains are also possible by reducing the proportion of the time that the motor(s) operate at very low speeds where efficiency is reduced. The wider speed range of motors means that the number of ratios required is lower than for combustion engine vehicles, with two to four speed designs emerging as the optimum depending on application.

Initially the Tesla Roadster was intended to have a purpose-built two-speed manual transmission^[8] but this gearbox proved to be problematic and was later replaced with a fixed-ratio transmission.

Gear ratios[edit]

The slowest gears (designated '1' or low gear) in most automotive applications allow for three to four engine rotations for each output revolution (3:1). High, or "top", gear in many earlier three or four speed manual transmissions locks the output shaft to spin at the same speed as the engine (1:1). Five and six speed gearboxes are almost always 'overdrive' in top gear with the engine turning less than a full turn for each revolution of the output shaft, 0.8:1 for example (however, the final drive, or differential, always has further reduction gearing).

External overdrive[edit]

Main article: Overdrive

In the 1950s, 1960s, and 1970s, fuel-efficient highway cruising with low engine speed was in some cases enabled on cars equipped with 3- or 4-speed transmissions by means of a separate overdrive unit in or behind the rear housing of the transmission. This was actuated either manually while in high gear by throwing a switch or pressing a button on the gearstick knob or on the steering column, or automatically by momentarily lifting the foot from the accelerator with the car travelling above a certain road speed. Automatic overdrives were disengaged by flooring the accelerator, and a lockout control was provided to enable the driver to disable overdrive and operate the transmission as a normal (non-overdrive) transmission.^[9]

Shaft and gear configuration[edit]

On a conventional rear-drive transmission, there are three basic shafts; the input, the output, and the countershaft. The input and output together are called the *mainshaft*, since they are joined inside the transmission so they appear to be a single shaft, although they rotate totally independently of each other. The input length of this shaft is much shorter than the output shaft. Parallel to the mainshaft is the countershaft. There are a number of gears fixed along the countershaft, and matching gears along the output shaft, although these are not fixed, and rotate independently of the output shaft. There are sliding *dog collars*, or *dog clutches*, between the gears on the output shaft, and to engage a gear to the shaft, the collar slides into the space between the shaft and the inside space of the gear, thus rotating the shaft as well. One collar is usually mounted between two gears, and slides both ways to engage one or the other gears, so on a four-speed there would be two collars. A front-drive transmission is basically the same, but may be simplified. There often are two shafts, the input and the output, but depending on the direction of rotation of the engine, three may be required. Rather than the input shaft driving the countershaft with a pinion gear, the input shaft takes over the countershaft's job, and the output shaft runs parallel to it. The gears are positioned and engaged just as they are on the countershaft and output shaft of a rear-drive. This merely eliminates one major component, the pinion gear. Part of the reason that the input and output are in-line on a rear drive unit is to relieve torsional stress on the transmission and mountings, but this isn't an issue in a front-drive as the gearbox is integrated into the transaxle.

The basic process is not universal. The fixed and free gears can be mounted on either the input or output shaft, or both.

The distribution of the shifters is also a matter of design; it need not be the case that all of the free-rotating gears with selectors are on one shaft, and the permanently splined gears on the other. For instance a five-speed transmission might have the first-to-second selectors on the countershaft, but the third-to-fourth selector and the fifth selector on the mainshaft, which is the configuration in the 1998 Honda Civic. This means that when the car is stopped and idling in neutral with the clutch engaged and the input shaft spinning, the third, fourth and fifth gear pairs do not rotate.

In some transmission designs (Volvo 850 and V/S70 series, for example) there are actually two countershafts, both driving an output pinion meshing with the front-wheel-drive transaxle's ring gear. This allows the transmission designer to make the transmission narrower, since each countershaft need only be half as long as a traditional countershaft with four gears and two shifters.

Freewheeling^[edit]

Some automotive manual transmissions had freewheeling capability in the 1930s through 1960s.

Clutch^[edit]

Main article: Clutch

In all vehicles using a transmission (virtually all modern vehicles), a coupling device is used to separate the engine and transmission when necessary. This is because an internal-combustion engine must continue to run when in use, although a few modern cars shut off the engine when the vehicle is stationary. The clutch accomplishes this in manual transmissions. Without it, the engine and tires would at all times be inextricably linked, and any time the vehicle stopped, the engine would stall. Without the clutch, changing gears would be very difficult, even with the vehicle moving already: deselecting a gear while the transmission is under load requires considerable force (and risks significant damage). As well, selecting a gear requires the revolution speed of the engine to be held at a very precise value which depends on the vehicle speed and desired gear – the speeds inside the transmission have to match. In a car, the clutch is usually operated by a pedal; on a motorcycle, a lever on the left handlebar serves the purpose.

- When the clutch pedal is fully depressed, the clutch is fully disengaged, and no torque is transferred from the engine to the transmission (and by extension to the drive wheels). In this uncoupled state it is possible to select gears or to stop the car without stopping the engine.
- When the clutch pedal is fully released, the clutch is fully engaged and all of the engine's torque is transferred. In this coupled state, the clutch does not slip, but rather acts as rigid coupling to transmit power to the gearbox.
- Between these extremes of engagement and disengagement the clutch slips to varying degrees. When slipping it still transmits torque despite the difference in speeds between the engine crankshaft and the transmission input. Because this torque is transmitted by means of friction rather than direct mechanical contact, considerable power is wasted as heat (which is dissipated by the clutch). Properly applied, slip allows the vehicle to be started from a standstill, and when it is already moving, allows the engine rotation to gradually adjust to a newly selected gear ratio.
- Learning to use the clutch efficiently requires the development of muscle memory and a level of coordination.
- A rider of a highly tuned motocross or off-road motorcycle may "hit" or "fan" the clutch when exiting corners to assist the engine in revving to the point where it delivers the most power.

The clutch is typically disengaged by a thrust bearing that makes contact with pressure petals on the clutch ring plate and pushes them inward to release the clutch pad friction. Normally the bearing remains retracted away from the petals and does not spin. However, the bearing can be "burned out" and damaged by using the clutch pedal as a foot rest, which causes the bearing to spin continuously from touching the clutch plates.

Float shifting^[edit]

Main article: Float shifting

Float shifting or floating gears is changing gears without depressing the clutch, usually on a non-synchronized transmission. Since the clutch is not used, it is easy to mismatch speeds of gears, and the driver can quickly cause major (and expensive) damage to the gears and the transmission. Float shifting is often done on large trucks with standard (non-synchronized) gearboxes.

Gear shift types[edit]

Floor-mounted shifter[edit]

Main article: Gear stick

In most vehicles with manual transmission, gears are selected by manipulating a lever called a gear stick, shift stick, gearshift, gear lever, gear selector, or shifter connected to the transmission via linkage or cables and mounted on the floor, dashboard, or steering column. Moving the lever forward, backward, left, and right into specific positions selects particular gears.

A sample layout of a four-speed transmission is shown below. N marks *neutral*, the position wherein no gears are engaged and the engine is decoupled from the vehicle's drive wheels. The entire horizontal line is a neutral position, though the shifter is usually spring-loaded so it will return to the centre of the N position if not moved to another gear. The R marks reverse, the gear position used for moving the vehicle backward.



This layout is called the shift pattern. Because of the shift quadrants, the basic arrangement is often called an *H-pattern*. The shift pattern is usually molded or printed on or near the gear knob.

Typically, first gear is engaged at the top left position with second below, third up to the right with fourth, below, and so on. The only other pattern used in production vehicle manual transmissions is known as a Dog-leg gearbox pattern. This pattern locates first at bottom left position, second up and to the right with third below, fourth up and to the right, and so on. This pattern is found primarily in race and race inspired vehicles. Placing the selection position for second gear above the position for third gear is desirable in racing as more frequent shifting occurs from second to third than from first to second.

Independent of the shift pattern, the location of the reverse gear may vary. Depending on the particular transmission design, reverse may be located at the upper left extent of the shift pattern, at the lower left, at the lower right, or at the upper right. There is often a mechanism that allows selection of reverse only from the neutral position, or a reverse lockout that must be released by depressing the spring-loaded gear knob or lifting a spring-loaded collar on the shift stick, to reduce the likelihood of the driver inadvertently selecting reverse.

"Three on the Tree" vs "Four on the Floor"[edit]

During the period when U.S. cars usually had only three forward speeds and the steering column was the most common shifter location, this layout was sometimes called "three on the tree". In contrast European cars and performance cars mostly used a four-speed transmission with floor-mounted shifters. This layout was then referred to as "four on the floor".

Most FR (front-engined, rear-wheel drive) cars have a transmission that sits between the driver and the front passenger seat. Floor-mounted shifters are often connected directly to the transmission. FF (front-engined, front-wheel drive) cars, RR (rear-engined, rear-wheel drive) cars and front-engined cars with rear-mounted gearboxes often require a mechanical linkage to connect the shifter to the transmission.

Column-mounted shifter[edit]



Column mounted gear shift lever in a Saab 96

Some cars have a gear lever mounted on the steering column of the car. A 3-speed column shifter, which came to be popularly known as a "three on the tree", began appearing in America in the late 1930s and became common during the 1940s and 1950s. If a U.S. vehicle was equipped with overdrive, it was very likely to be a Borg-Warner type, operated by briefly backing off the gas when above 28 mph (45 km/h) to enable, and momentarily flooring the gas pedal to return to normal gear. The control simply disables overdrive for such situations as parking on a hill or preventing unwanted shifting into overdrive.^[*citation needed*]

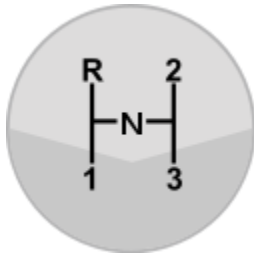

Later,^[*vague*] European and Japanese models began to have 4-speed column shifters with this shift pattern:

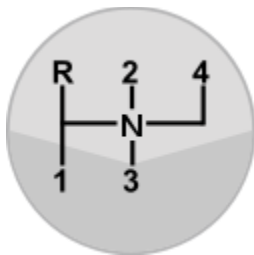

A majority of American-spec vehicles sold in the U.S. and Canada had a 3-speed column-mounted shifter—the first generation Chevrolet/GMC vans of 1964-70 vintage had an ultra-rare 4-speed column shifter. The column-mounted manual shifter disappeared in North America by the mid-1980s, last appearing in the 1987 Chevrolet pickup truck. Outside North America, the column-mounted shifter remained in production. All Toyota Crown and Nissan Cedric taxis in Hong Kong had the 4-speed column shift until 1999 when automatic transmissions were first offered. Since the late 1980s or early 1990s,^[*vague*] a 5-speed column shifter has been offered in some vans sold in Asia and Europe, such as Toyota Hiace, Mitsubishi L400 and the first-gen Fiat Ducato.

Column shifters are mechanically similar to floor shifters, although shifting occurs in a vertical plane instead of a horizontal one. Because the shifter is further away from the transmission, and the movements at the shifter and at the transmission are in different planes, column shifters require more complicated linkage than floor shifters. Advantages of a column shifter are the ability to switch between the two most commonly used gears—second and third—without letting go of the steering wheel, and the lack of interference with passenger seating space in vehicles equipped with a bench seat.

Console-mounted shifter[edit]

Some smaller cars in the 1950s and 1960s, such as Citroën 2CV, Renault 4L and early Renault 5 feature a shifter in the dash panel. This was cheaper to manufacture than a column shifter and more practical, as the gearbox was mounted in front of the engine. The linkage for the shifter could then be positioned on top of the engine. The disadvantage is that shifting is less comfortable and usually slower to operate.

Newer small cars and MPVs, like the Suzuki MR Wagon, the Fiat Multipla, the Toyota Matrix, the Pontiac Vibe, the Chrysler RT platform cars, the Honda Element, the Honda Civic, and the Honda Avancier may feature a manual or automatic transmission gear shifter located on the vehicle's instrument panel, similar to the mid-1950s Chryslers and PowerglideCorvairs. Console-mounted shifters are similar to floor-mounted gear shifters in that most of the ones used in modern cars operate on a horizontal plane and can be mounted to the vehicle's transmission in much the same way a floor-mounted shifter can. However, because of the location of the gear shifter in comparison to the locations of the column shifter and the floor shifter, as well as the positioning of the shifter to the rest of the controls on the panel often require that the gearshift be mounted in a space that does not feature a lot of controls integral to the vehicle's operation or frequently used controls, such as those for the car stereo or car air conditioning, to help prevent accidental activation or driver confusion, especially in right-hand drive cars.

More and more small cars and vans from manufacturers such as Suzuki, Honda, and Volkswagen are featuring console shifters in that they free up space on the floor for other car features such as storage compartments without requiring that the gear shift be mounted on the steering column. Also, the basic location of the gear shift in comparison to the column shifter makes console shifters easier to operate than column shifters.

Sequential manual[edit]

Main article: Sequential manual transmission

Some transmissions do not allow the driver to arbitrarily select any gear. Instead, the driver may only ever select the next-lower or next-higher gear ratio. Sequential transmissions often incorporate a synchro-less dog-clutch engagement mechanism (instead of the synchromesh dog clutch common on H-pattern automotive transmissions), in which case the clutch is only necessary when selecting first or reverse gear from neutral, and most gear changes can be performed without the clutch. However, sequential shifting and synchro-less engagement are not inherently linked, though they often occur together due to the environment(s) in which these transmissions are used, such as racing cars and motorcycles.

Sequential transmissions are generally controlled by a forward-backward lever, foot pedal, or set of paddles mounted behind the steering wheel. In some cases, these are connected mechanically to the transmission. In many modern examples, these controls are attached to sensors which instruct a transmission computer to perform a shift—many of these systems can be switched into an automatic mode, where the computer controls the timing of shifts, much like an automatic transmission.

In motorcycles[edit]

Motorcycles typically employ sequential transmissions, although the shift pattern is modified slightly for safety reasons. In a motorcycle the gears are usually shifted with the left foot pedal, the layout being this:



The gear shift lever on a 2003 Suzuki SV650S motorcycle.

1 - N - 2 - 3 - 4 - 5 (- 6)

The pedal goes one step—both up and down—from the center, before it reaches its limit and has to be allowed to move back to the center position. Thus, changing multiple gears in one direction is accomplished by repeatedly pumping the pedal, either up or down. Although neutral is listed as being between first and second gears for this type of transmission, it "feels" more like first and second gear are just "further away" from each other than any other two sequential gears. Because this can lead to difficulty in finding neutral for inexperienced riders most motorcycles have a neutral indicator light on the instrument panel to help find neutral. The reason neutral does not actually have its own spot in the sequence is to make it quicker to shift from first to second when moving. Neutral can be accidentally shifted into, though most high end, newer model motorcycles have means of avoiding this.^[*citation needed*] The reason for having neutral between the first and second gears instead of at the bottom is that when stopped, the rider can just click down repeatedly and know that they will end up in first and not neutral. This allows a rider to quickly move his bike from a standstill in an emergency situation. This may also help on a steep hill on which high torque is required. It could be disadvantageous or even dangerous to attempt to be in first without realizing it, then try for a lower gear, only to get neutral.

On motorcycles used on race tracks, the shifting pattern is often reversed, that is, the rider clicks down to upshift. This usage pattern increases the ground clearance by placing the rider's foot above the shift lever when the rider is most likely to need it, namely when leaning over and exiting a tight turn.

The shift pattern for most underbone or miniature motorcycles with an automatic centrifugal clutch is also modified for two key reasons—to enable the less-experienced riders to shift the gears without problems of "finding" neutral, and also due to the greater force needed to "lift" the gearshift lever (because the gearshift pedal of an underbone motorcycle also operates the clutch). The gearshift lever of an underbone has two ends. The rider clicks down the front end with the left toe all the way to the top gear and clicks down the rear end with the heel all the way down to neutral, while miniatures still retain a single-end lever, with the rider clicks down to upshift and lift the lever up to downshift (or vice versa). Some underbone models such as the Honda Wave have a "rotary" shift pattern, which means that the rider can shift directly to neutral from the top gear, but for safety reasons this is only possible when the motorcycle is stationary. Some models also have gear position indicators for all gear positions at the instrument panel.

Semi-manual[edit]

Some new transmissions (Alfa Romeo's Selespeed gearbox and BMW's *Sequential Manual Gearbox* (SMG) for example) are conventional manual transmissions with a computerized control mechanism. These transmissions feature independently selectable gears but do not have a clutch pedal. Instead, the transmission computer controls a servo which disengages the clutch when necessary.

These transmissions vary from sequential transmissions in that they still allow nonsequential shifts: the SMG system formerly used by BMW, for example, could shift from 6th gear directly to 4th gear.

An early version of this type of transmission was the Autostick, which was used in the Volkswagen Beetle and Karmann Ghia from 1967 to 1976, where the clutch was disengaged by servo when the driver pushed downward slightly on the gear shift lever. This was a 3-speed unit.

In the case of the early second generation Saab 900, a 'Sensonic' option was available where gears were shifted with a conventional shifter, but the clutch is controlled by a computer.

See semi-automatic transmission for more examples.

Short shifter[edit]



Comparison between a stock shifter and a short shifter

A short shifter, also known as a short throw shifter, is the result of an automotive aftermarket modification of the manual transmissions' stick shift either by modification of the existing stick shift or, alternately, by the replacement of the entire part.

The purpose of the modification is to mechanically reduce time between the changing of gears while accelerating or decelerating, thus improving the automobiles' performance. The modification of the existing stick shift, also known as a manual gear stick, can take two forms: either the physical shortening of the existing stick shift, known in the industry as 'chopping', or bending. By reducing the length of the stick shift, the distance it must travel to change gears is effectively reduced, thus reducing the time spent shifting. At the same time, the amount of force required to shift increases due to a shorter lever.

Some major car manufacturers such as Subaru, Mazda and Porsche offer short shifters as stock modifications such as in the Subaru WRX, Subaru WRX STI, Subaru BRZ, Mazda Miata, and as an option such as in the Porsche 911.^{[10][11]}

Finger shift[edit]



This section needs expansion. You can help

by adding to it. (*July 2014*)

In Japan, finger shift is used on buses. Its system is made by Robert Bosch GmbH. Sometimes it is also referred as Electro-pneumatic gearbox or Finger control transmission (FCT).

In shift operations using mechanical link mechanisms in rear-engined buses, the FCT detected the position of the shift lever and converted it into an electronic signal. These signals were then used to perform transmission changes using air pressure. This resulted in easy shift changes and reduced driver fatigue, and also reduced the weight of the link mechanism. A pseudo-reaction force was added to the operation to reduce driver discomfort. Moreover, elaborate fail-safe mechanisms were incorporated, such as one that prevented mis-shifts, and one that assured safe driving in the event of system failure. The FCT was used in MP series heavy duty route buses from November 1983 after basic research and multiple prototypes and practical tests over 10 years. It gained popularity in combination with measures to assist older drivers, and in the following year, it was applied to large heavy duty tour buses.

Maintenance[edit]

Because clutches use changes in friction to modulate the transfer of torque between engine and transmission, they are subject to wear in everyday use. A very good clutch, when used by an expert driver, can last hundreds of thousands of kilometres (or miles). Weak clutches, abrupt downshifting, inexperienced drivers, and aggressive driving can lead to more frequent repair or replacement.

Manual transmissions are lubricated with gear oil or engine oil in some cars, which must be changed periodically in some cars, although not as frequently as the automatic transmission fluid in a vehicle so equipped. (Some manufacturers specify that changing the gear oil is never necessary except after transmission work or to rectify a leak.)

Gear oil has a characteristic aroma due to the addition of sulfur-bearing anti-wear compounds. These compounds are used to reduce the high sliding friction by the helical gear cut of the teeth (this cut eliminates the characteristic whine of straight cut spur gears). On motorcycles with "wet" clutches (clutch is bathed in engine oil), there is usually nothing separating the lower part of the engine from the transmission, so the same oil lubricates both the engine and transmission. The original Mini placed the gearbox in the oil sump below the engine, thus using the same oil for both. The clutch was however a fairly conventional dry plate clutch.

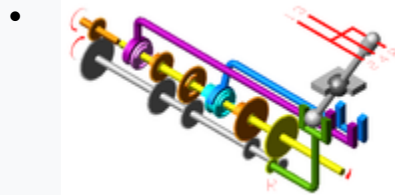

Reverse (green engaged)

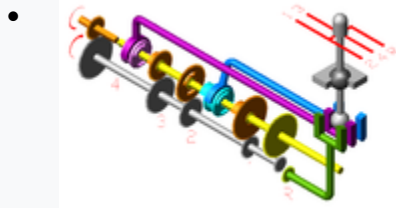

Neutral (blue and purple in the middle, green disengaged)

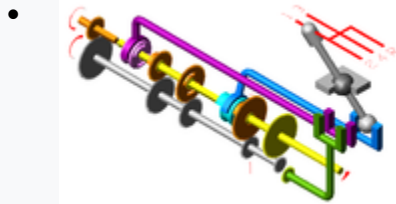

First gear (blue, to back)

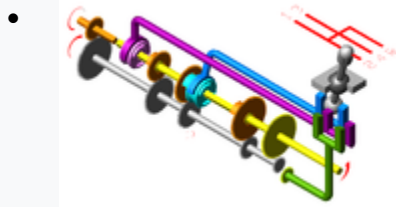

Second gear (blue, to front)

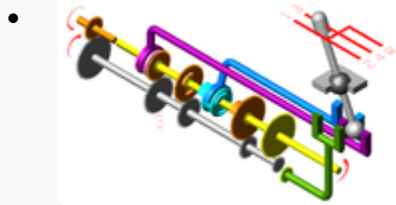

Third gear (purple, to back)

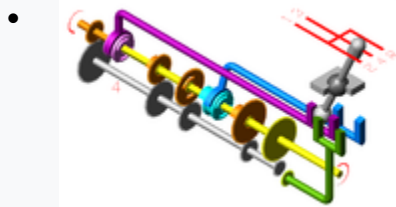

Fourth gear (purple, to front)

Differential gear

The differential is an integral part of all four wheelers. Differential technology was invented centuries ago and is considered to be one of the most ingenious inventions human thinking has

ever produced. In this video, we will learn, in a logical manner, why a differential is needed in an automobile and its inner workings.

Why the Differential gear is used?

Wheels receive power from the engine via a drive shaft. The wheels that receive power and make the vehicle move forward are called the drive wheels. The main function of the differential gear is to allow the drive wheels to turn at different rpms while both receiving power from the engine.

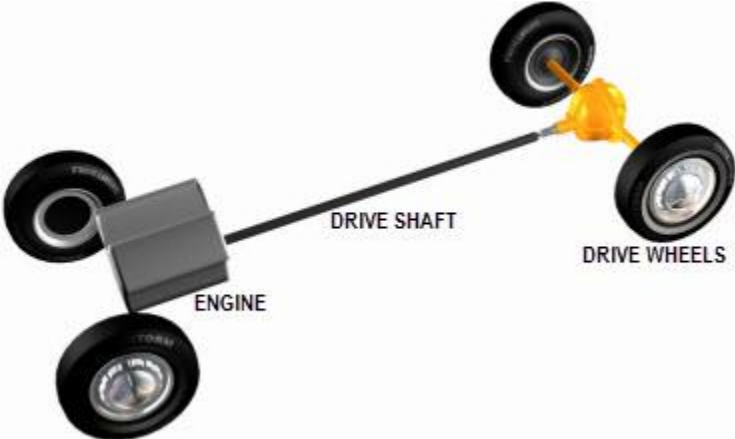

Fig.1 Power from the engine is flowed to the wheels via a drive shaft

Consider these wheels, which are negotiating a turn. It is clear that the left wheel has to travel a greater distance compared to the right wheel.

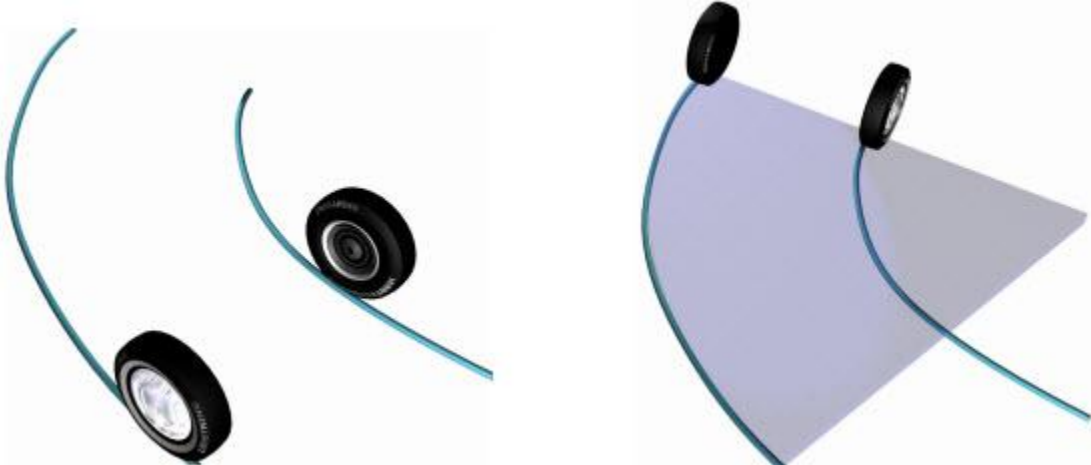

Fig.2 While taking a right turn the left wheel has to travel more distance; this means more speed to left wheel

This means that the left wheel has to rotate at a higher speed compared to the right wheel. If these wheels were connected using a solid shaft, the wheels would have to slip to accomplish the turn. This is exactly where a differential comes in handy. The ingenious mechanism in a differential allows the left and right wheels to turn at different rpms, while transferring power to both wheels.

Parts of a Differential

We will now learn how the differential achieves this in a step-by-step manner using the simplest configuration. Power from the engine is transferred to the ring gear through a pinion gear. The ring gear is connected to a spider gear.

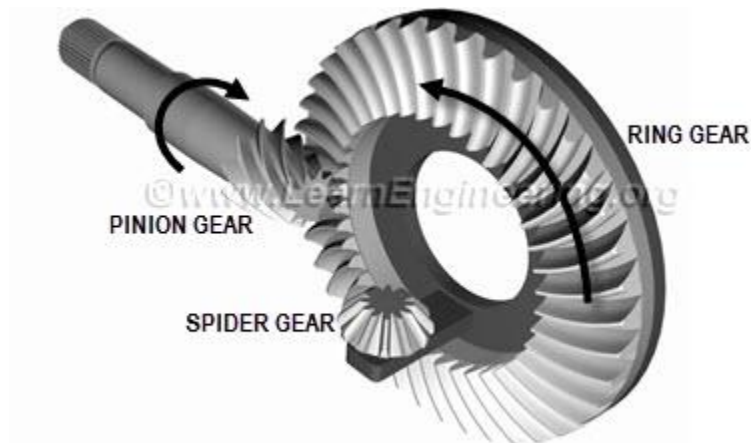

Fig.3 Motion from the pinion gear is transferred to the spider gear

The spider gear lies at the heart of the differential, and special mention should be made about its rotation. The spider gear is free to make 2 kinds of rotations: one along with the ring gear (*rotation*) and the second on its own axis (*spin*).

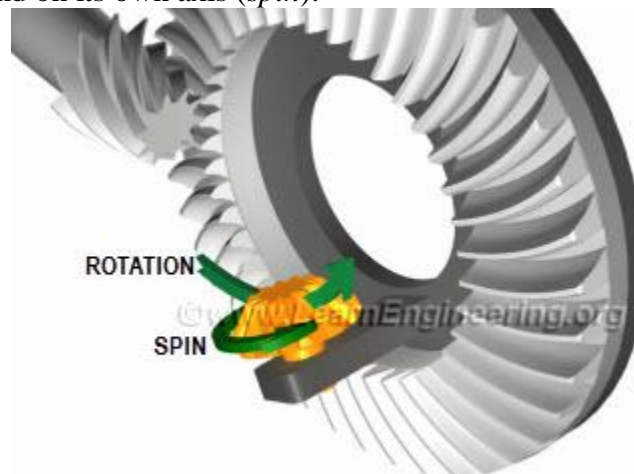

Fig.4 Spider gear is free to make 2 kinds of rotations

The spider gear is meshed with 2 side gears. You can see that both the spider and side gears are bevel gears. Power flow from the drive shaft to the drive wheels follows the following pattern. From the drive shaft power is transferred to the pinion gear first, and since the pinion and ring gear are meshed, power flows to the ring gear. As the spider gear is connected with the ring gear, power flows to it. Finally from the spider gear, power gets transferred to both the side gears.

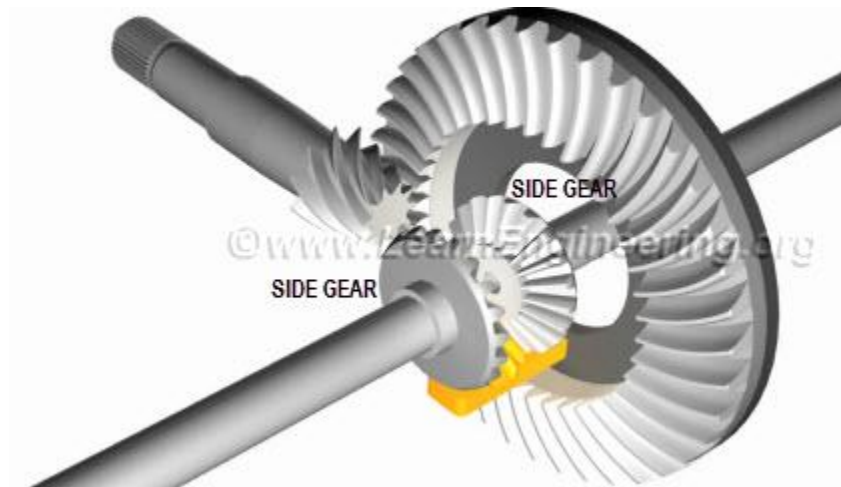

Fig.5 The basic components of a standard differential

Differential Operation

Now let's see how the differential manages to rotate the side gears (drive wheels) at different speeds as demanded by different driving scenarios.

The vehicle moves straight

In this case, the spider gear rotates along with the ring gear but does not rotate on its own axis. So the spider gear will push and make both the side gears turn, and both will turn at the same speed. In short, when the vehicle moves straight, the spider-side gear assembly will move as a single solid unit.



Fig.6 While the vehicle moves straight, the spider gear does not spin; it pushes and rotate the side gears

The vehicle takes a right turn

Now consider the case when the vehicle is taking a right turn. The spider gear plays a pivotal role in this case. Along with the rotation of the ring gear it rotates on its own axis. So, the spider gear is has a combined rotation. The effect of the combined rotation on the side gear is interesting.

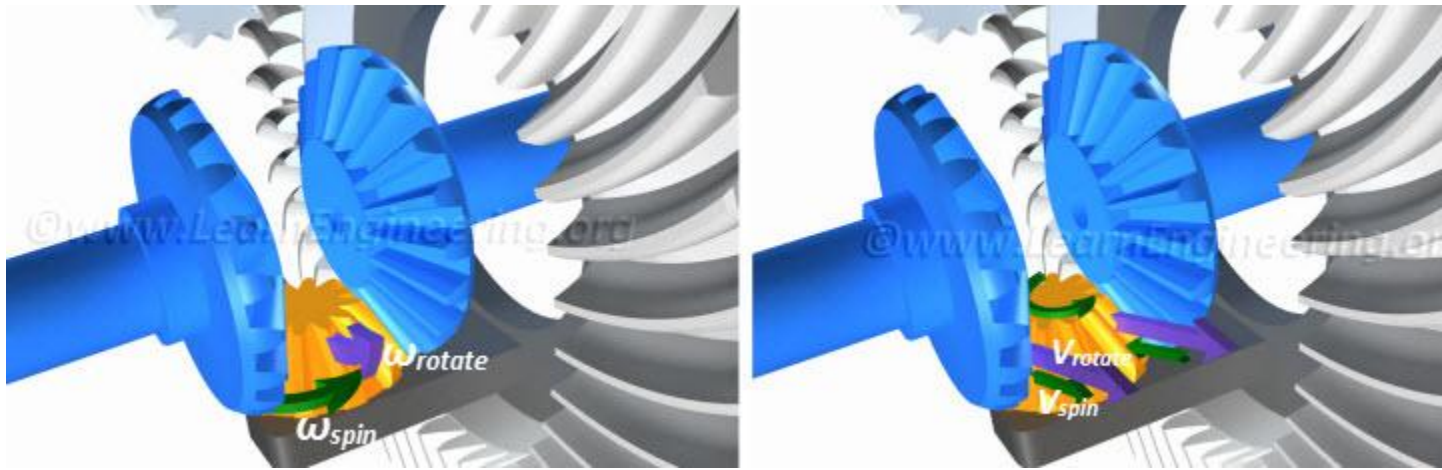

Fig.7 To get peripheral velocity at left and right side of spider gear we have to consider both rotation and spin of it

When properly meshed, the side gear has to have the same peripheral velocity as the spider gear. Technically speaking, both gears should have the same pitch line velocity. When the spider gear is spinning as well as rotating, peripheral velocity on the left side of spider gear is the sum of the spinning and rotational velocities. But on the right side, it is the difference of the two, since the spin velocity is in the opposite direction on this side. This fact is clearly depicted in Fig.7. This means the left side gear will have higher speed compared to the right side gear. This is the way the differential manages to turn left and right wheels at different speeds.

The vehicle takes a left turn

While taking a left turn, the right wheel should rotate at a higher speed. By comparing with the previous case, it is clear that, if the spider gear spins in the opposite direction, the right side gear will have a higher speed.



Fig.8 While taking left turn the spider gear spins in opposite direction

Use of more Spider gears

In order to carry a greater load, one more spider gear is usually added. Note that the spider gears should spin in opposite directions to have the proper gear motion. A four-spider-gear arrangement is also used for vehicles with heavy loads. In such cases, the spider gears are connected to ends of a cross bar, and the spider gears are free to spin independently.



Fig.9 Double spider gear arrangement is usually used to carry more loads

Other functions of the Differential

Apart from allowing the wheels to rotate at different rpm differential has 2 more functions. First is speed reduction at the pinion-ring gear assembly. This is achieved by using a ring gear which is having almost 4 to 5 times number of teeth as that of the pinion gear. Such huge gear ratio will bring down the speed of the ring gear in the same ratio. Since the power flow at the pinion and ring gear are the same, such a speed reduction will result in a high torque multiplication.

You can also note one specialty of the ring gear, they are hypoid gears. The hypoid gears have more contact area compared to the other gear pairs and will make sure that the gear operation is smooth.

The other function of the differential is to turn the power flow direction by 90 degree.

Drawback of a Standard Differential

The differential we have gone through so far is known as *open* or *standard differential*. It is capable of turning the wheels at different rpm, but it has got one major drawback. Consider a situation where one wheel of the vehicle is on a surface with good traction and the other wheel on a slippery track.

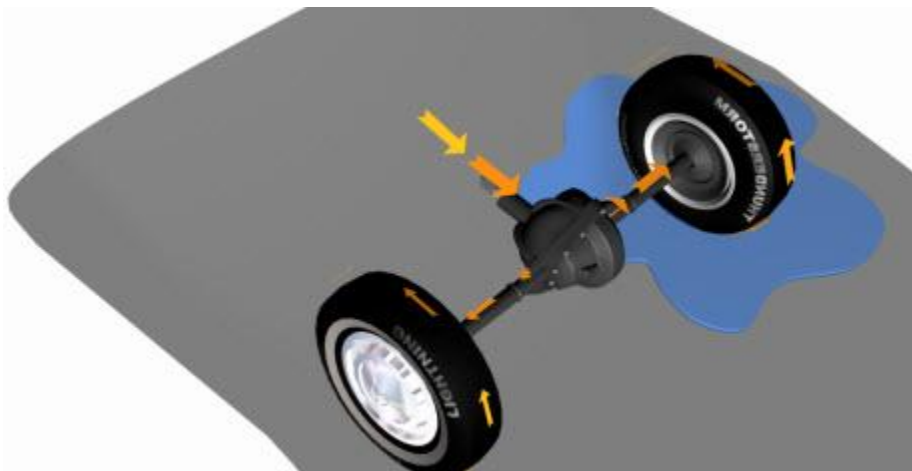

Fig.10 A standard differential vehicle on different traction surfaces will not be able to move

In this case a standard differential will send the majority of the power to the slippery wheel, so the vehicle won't be able to move. To overcome this problem, Limited Slip Differentials are introduced. We will learn more about them in a separate article.

Clutches

If you drive a manual transmission car, you may be surprised to find out that it has more than one clutch. And it turns out that folks with automatic transmission cars have clutches, too. In fact, there are clutches in many things you probably see or use every day: Many cordless drills have a clutch, chain saws have a centrifugal clutch and even some yo-yos have a clutch.

In this article, you'll learn why you need a clutch, how the clutch in your car works and find out some interesting, and perhaps surprising, places where clutches can be found.

Clutches are useful in devices that have two rotating shafts. In these devices, one of the shafts is typically driven by a motor or pulley, and the other shaft drives another device. In a drill, for instance, one shaft is driven by a motor and the other drives a drill chuck. The clutch connects the two shafts so that they can either be locked together and spin at the same speed, or be decoupled and spin at different speeds.

In a car, you need a clutch because the engine spins all the time, but the car's wheels do not. In order for a car to stop without killing the engine, the wheels need to be disconnected from the engine somehow. The clutch allows us to smoothly engage a spinning engine to a non-spinning transmission by controlling the slippage between them.

To understand how a clutch works, it helps to know a little bit about friction, which is a measure of how hard it is to slide one object over another. Friction is caused by the peaks and valleys that are part of every surface -- even very smooth surfaces still have microscopic peaks and valleys. The larger these peaks and valleys are, the harder it is to slide the object. You can learn more about friction in [How Brakes Work](#).

A clutch works because of friction between a clutch plate and a flywheel. We'll look at how these parts work together in the next section.

How a clutch engages and releases

When the clutch pedal is pressed, a cable or hydraulic piston pushes on the release fork, which presses the throw-out bearing against the middle of the diaphragm spring. As the middle of the diaphragm spring is pushed in, a series of pins near the outside of the spring causes the spring to pull the pressure plate away from the clutch disc (see below). This releases the clutch from the spinning engine.



© 2000 How Stuff Works

Clutch plate

PHOTO COURTESY CAROLINA MUSTANG

Note the springs in the clutch plate. These springs help to isolate the transmission from the shock of the clutch engaging.

This design usually works pretty well, but it does have a few drawbacks. We'll look at common clutch problems and other uses for clutches in the following sections.

regenerative braking system

Instead of wasting the potential energy associated with the BackEMF voltage of a vehicle's electric motor via heat loss, it can be used to recharge the battery and therefore recover energy for higher system efficiency. Certain manufacturing processes can be made more efficient in similar ways. See diagrams, graphics, and equations.

In the motion control industry, the term “regeneration” or “regenerative braking” refers to using the power associated with the BackEMF (back electromotive force) voltage of an electric motor to charge a battery. This is the opposite of the normal operational mode where the battery is used to provide power to an electric motor. However, since an electric motor can act as a generator, a system can be designed where the power flow (in or out) of the motor and battery can change in real time. So, instead of throwing away the BackEMF power into heat loss, it can be used to recharge the battery, thereby recovering energy, adding to overall system efficiency. See Figure 1 below.

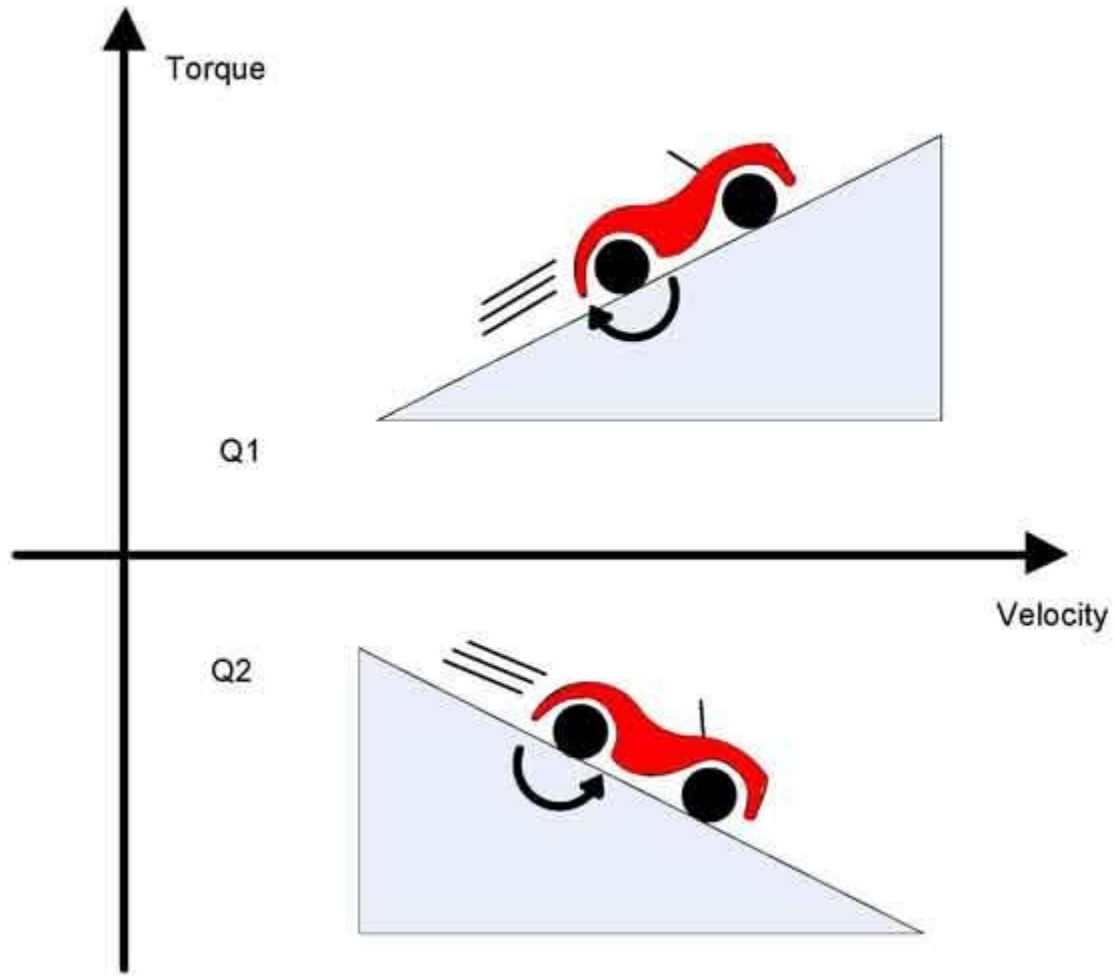

Gravity testing

Many motor/battery systems have the potential for regeneration including those used for manufacturing. In battery-powered vehicles that use a permanent magnet motor as the drive, the system is simple with an intrinsic steady-state regeneration condition (until the bottom of the hill is reached). The drive system will operate in all “four quadrants,” meaning the drive must be able to control both the acceleration and deceleration of the vehicle in both forward and reverse. At steady state there exists the possibility to use the motor's BackEMF voltage to recharge the battery in two of the four quadrants. Under the right conditions this can make a significant contribution to the system's power efficiency in the context of extending the time between battery charges.

Figure 1 shows the vehicle operating in two of the four quadrants, one being positive velocity/ positive torque, the other being positive velocity/ negative torque. The other two quadrants can easily be realized by reversing the sign of velocity. The direction of rotation of the motor will determine the sign of the motor's BackEMF voltage, and the magnitude of the velocity will determine the magnitude of the motor's BackEMF voltage.

In Figure 1, the motor's BackEMF voltage is always positive and increases in magnitude with speed. It is assumed that the vehicle moving uphill will always need a “positive” torque as

indicated by the direction of the arrow. The vehicle moving downhill requires a “negative” torque from the motor to brake the car and prevent a runaway condition.

Motor model

Figure 2 demonstrates the standard single-phase motor model (resistive, inductive, and BackEMF components) whereby positive current flow corresponds to motor torque in the positive direction. The polarity relationship between the battery voltage and motor's BackEMF voltage stems from that current flow convention. (The polarity of the motor's BackEMF voltage is rotation direction dependent and will oppose the direction of current flow that generates torque in the same direction.) See Figure 2 below.

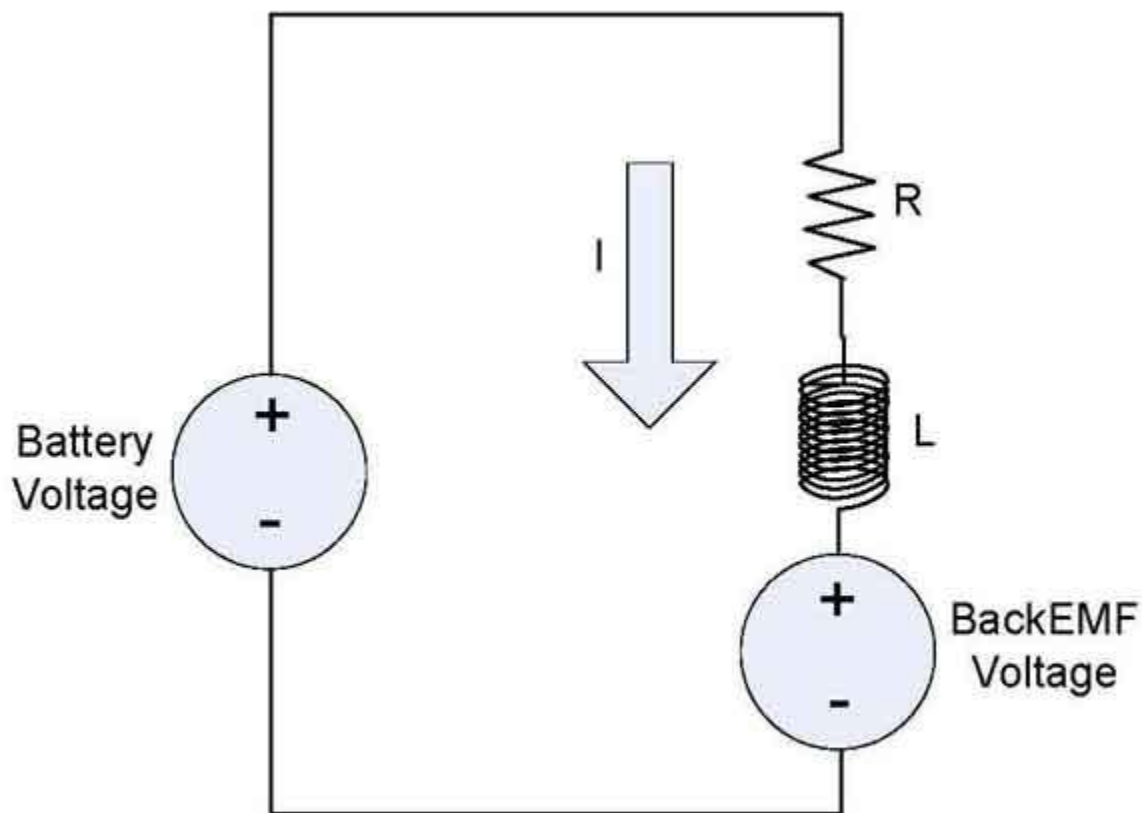

Control of the vehicle under the given conditions requires proportional control of the current in the motor. This is achieved by using a voltage regulation scheme that can apply a portion of the battery voltage to the motor with either positive or negative polarity. This proportional voltage is referred to as an “effective voltage” (V_{eff}). This concept is the foundation for common servo motor drives (linear and PWM switching) where proportional control is required. The effective voltage, along with the motor components, is used in the standard electrical motor equation, which can be derived from Figure 2 after substituting effective voltage for the battery voltage.

$$V_{eff} = Ri + L(di/dt) + V_{emf}$$

Up until now the left-hand side of Figure 3 has not been discussed. In this half, the velocity is negative and therefore the BackEMF voltage is also negative. The polarity relationship between BackEMF voltage and effective voltage is preserved. In the case of negative BackEMF voltage, the effective voltage must also be negative and the current must be positive for regeneration to occur at a steady state.

Figure 3 was derived for the given system but is valid for simple inertial systems driven by a motor operating at steady state. In other systems, external forces could alter the location of the operational envelope defined there.

H-bridge analysis

An H-bridge is the most common scheme used to implement a four-quadrant PWM controller on a brushed dc servo motor. The PWM duty cycle controls the proportion of the supply voltage (battery) that the motor is exposed to, which has been previously referred to as the effective voltage.

A steady-state analysis will be performed at a point in the positive velocity regeneration region. The motor winding current at steady state can be expressed in terms of effective voltage, BackEMF voltage and winding resistance.

$$I_{ss} = (V_{eff} - V_{emf})/R$$

The steady-state selection point results in the following requirements:

- $V_{eff} > 0$
- $V_{emf} > 0$
- $V_{emf} > V_{eff}$
- $V_{batt} > V_{emf} + RI$

A motor controller will control the effective voltage to the motor by controlling the four MOSFETs (metal-oxide-semiconductor field-effect transistors) of the H Bridge shown in Figure 4, below.

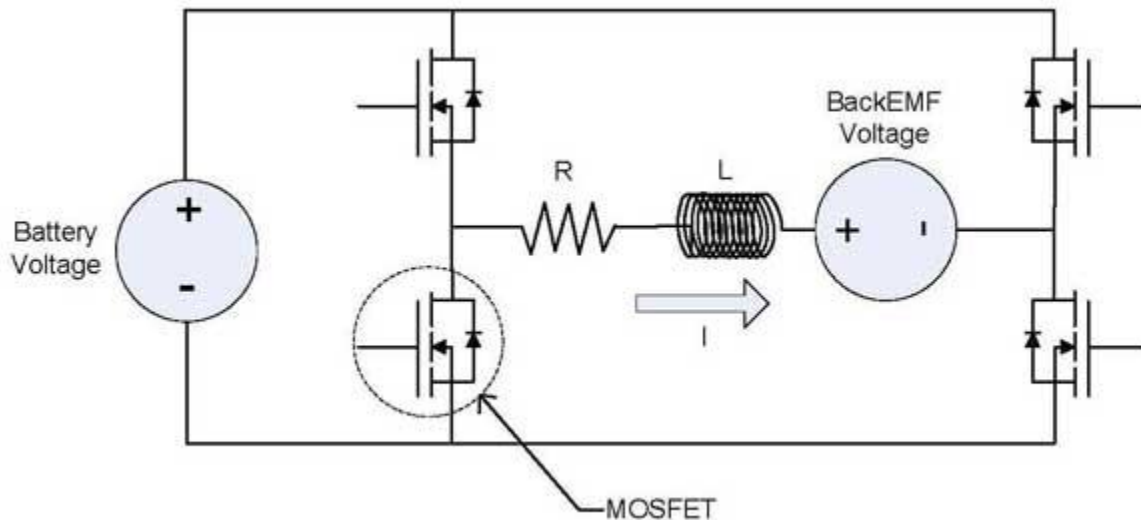

Various switching schemes exist for controlling the four MOSFETs, one of which will be used here. We now join the PWM cycle with the system at a steady state with an average negative current (opposite the direction shown in Figure 4), positive BackEMF voltage, and positive effective voltage. Looking inside the PWM period there are four MOSFET drive states occurring over one PWM cycle, in this order:

1. High sides off / low sides on

The current is recirculating in the lower MOSFETs. The BackEMF voltage causes the current to become more negative as the inductive energy stored in the motor windings is resistively dissipated. There is no flow to/from the battery and therefore no regeneration. The current will decrease at a rate of:

$$di/dt = (-V_{emf} - Ri)/L$$

2. Opposing MOSFETs on

Which pair of the MOSFETs depends on the sign of the effective voltage the controller wishes to apply. In this case (+V_{eff}), the upper left and lower right MOSFETs will be conducting. Since the remaining MOSFETs are not conducting, there is only one path for this negative current, which is back into the battery. The current will drift toward zero while energy is being dissipated in the resistive components as well as flowing into the battery. This is a state of regeneration and the battery is being charged. The current will decay at a rate of:

$$di/dt = (V_{batt} - V_{emf} - Ri)/L$$

Note: V_{batt} is the true battery voltage, not to be confused with effective voltage (V_{eff})

To simplify this proof, the battery is treated as an ideal power source with infinite current sink/source properties. The effects of battery efficiency will be discussed later.

3. High sides on / low sides off

Identical to the first state with the exception that the current is recirculating in the upper MOSFETs.

4. Opposing MOSFETs on

Identical to state 2, another case where regeneration is taking place. At the end of this state the PWM cycle has completed. Since a steady-state system has been defined, the instantaneous current will be equal to the instantaneous current at the beginning of state 1.

We have seen that in states 2 and 4, current is flowing into the battery. There are no conditions where current is flowing out of the battery in this analysis. The instantaneous power delivered to the battery is the battery voltage times the current. However, if the controller was applying an effective voltage that was 25% of the battery voltage, the combined times of states 2 plus 4 would equal 25% of the total PWM period. So, the average power delivered to the battery will be the battery voltage times the current times the duty cycle percentage.

Mechanical model

The analysis will be continued by creating a mechanical model of the electric vehicle. The model will be simplified by adhering to rigid body analysis only. This implies that elastic deformation of components like axles and drive shafts will be ignored and assumed to be zero. Additionally, there will be no frictional components included in the model, which implies the wheel and motor bearings are ideal and the gearing mechanism has no efficiency loss. This also implies that there is no wind drag on the model. This model can be used to gain insight into the nature of the energy recovery; however, if a real-world numerical estimate of the amount of energy recovered is required, the frictional and efficiency components need to be accounted for properly in the modeling process.

The model of the electric vehicle will be defined by a set of mechanical and electrical parameters. Figure 5 below defines two of these: The mass of the vehicle and the slope of the hill.

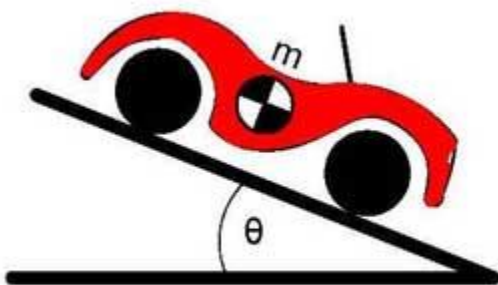

To model the motion of the vehicle and the resulting energy recovery, the mechanical drivetrain of the vehicle must be analyzed. This includes the motor and a gear assembly attached to one wheel. The other three wheels are free to spin. Figure 6 below depicts the forces and torques acting on the vehicle's drivetrain.

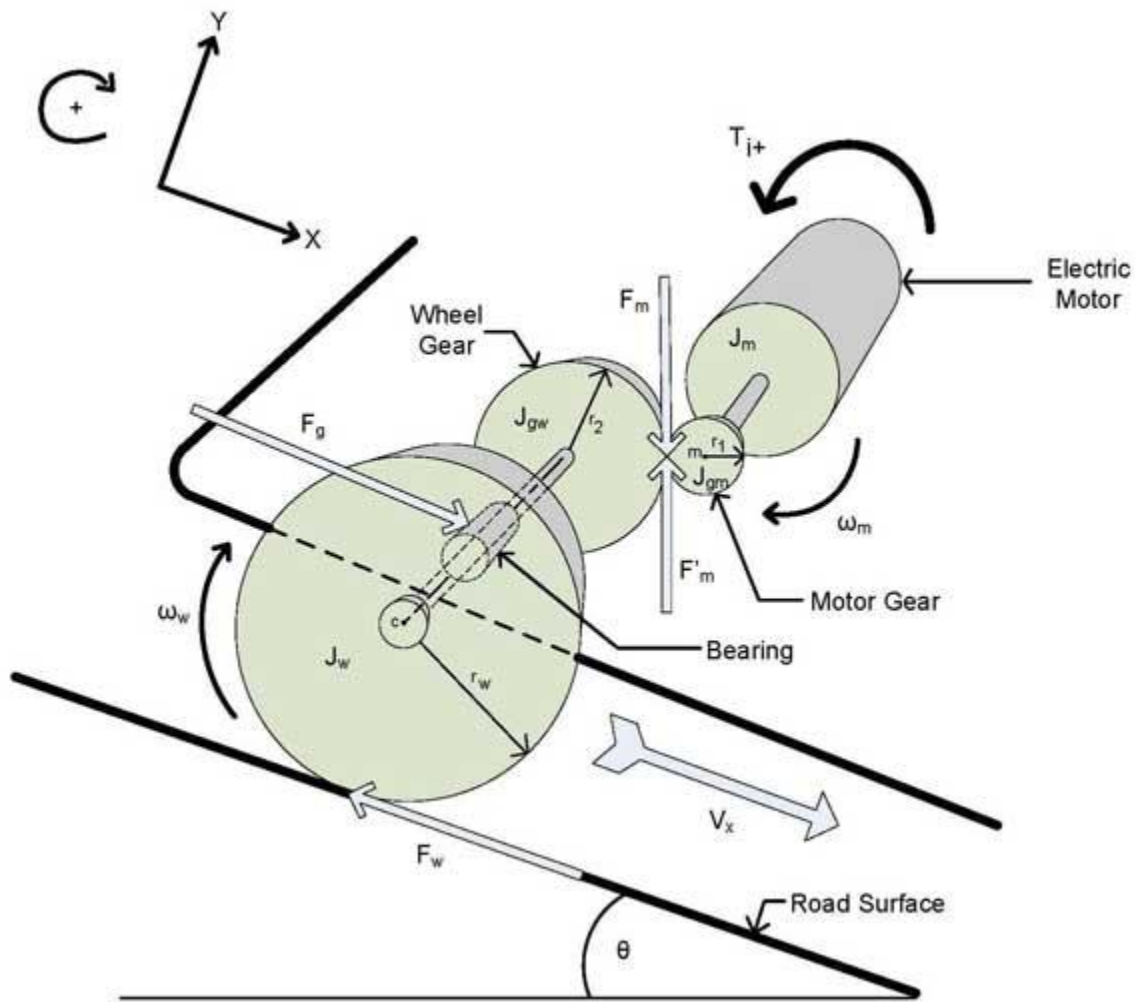

All translational motion of the vehicle occurs along the x-axis, which is always parallel to the road surface. The motor and motor gear rotate together as one rigid body. The “ T_{i+} ” arrow indicates the direction of torque produced by positive current. In accordance with the rotation direction defined here, this will be torque in the negative direction. F'_m is the force of the wheel gear acting on the motor gear. Summing the torques about the center of the motor gear (m) results in:

$$\sum T_m = F'_m r_1 - T_{i+} = J_1 \dot{\omega}_m \text{ where } J_1 = J_{gm} + J_m$$

Substituting Kt_i for T_{i+} and solving for F'_m results in:

$$F'_m = \frac{J_1 \dot{\omega}_m + K_t i}{r_1}$$

The wheel gear and wheel are also treated as one rigid body where the rotation of the wheel gear is equal to the rotation of the wheel. The axle bearing (see Figure 6) acts on this rigid body and ultimately transfers all gravitation and translational inertial forces. Summing the forces acting on this rigid body along the x-axis results in:

$$\sum F_x = F_w + F_g = m\dot{v}_x$$

Summing the torques about the center of the wheel (c) results in:

$$\sum T_c = F_m r_2 - F_w r_w = J_2 \dot{\omega}_w \text{ where } J_2 = J_g + J_w$$

Solving for F_w :

$$F_w = \frac{-J_2 \dot{\omega}_w + F_m r_2}{r_w}$$

A few system observations will allow for some useful substitutions.

- $F_m = -F'_m$
- Gear Ratio (η) = $\frac{r_1}{r_2}$
- $\omega_w = -\eta \omega_m$
- $\omega_w = \frac{v_x}{r_w}$ and $\omega_m = \frac{-v_x}{r_w \eta}$
- $\dot{\omega}_w = \frac{\dot{v}_x}{r_w}$ and $\dot{\omega}_m = \frac{-\dot{v}_x}{r_w \eta}$
- $F_g = mg \sin(\theta)$

Making substitutions in the force equation and letting $F_m = -F'_m$:

$$\frac{-J_2 \dot{\omega}_w + \frac{(-J_1 \dot{\omega}_m - K_i)}{r_1} r_2}{r_w} + mg \sin(\theta) = m\dot{v}_x$$

$$\left(\frac{1}{r_w}\right) \left[-J_2 \dot{\omega}_w + (+J_1 \dot{\omega}_m + K_i) \left(\frac{1}{\eta}\right)\right] + mg \sin(\theta) = m\dot{v}_x$$

The rotational velocity terms will now be replaced with linear velocity terms:

$$\frac{-\dot{v}_x}{r_w} \left(J_2 + \frac{J_1}{\eta}\right) + \frac{K_i}{r_w \eta} + mg \sin(\theta) = m\dot{v}_x$$

And then solve for:

$$\dot{v}_x = \frac{K_i}{r_w \eta \left[m + \left(\frac{1}{r_w}\right) \left(J_2 + \frac{J_1}{\eta}\right)\right]} + \frac{mg \sin(\theta)}{m + \left(\frac{1}{r_w}\right) \left(J_2 + \frac{J_1}{\eta}\right)}$$

Expansion of motor model

To facilitate use of the electrical equation in a system analysis, the BackEMF voltage will be expressed as a function of the vehicle velocity:

$$V_{emf} = K_B(-\omega_m) = \frac{K_B v_x}{r_w \eta}$$

Substituting back into the electrical equation for the motor and solving for di/dt :

$$\dot{i} = \frac{-K_B v_x}{r_w \eta L} - \frac{Ri}{L} + \frac{V_{emf}}{L}$$

Electromechanical model

At this point, two first-order ODEs have been created, one derived from mechanical properties and the other derived from electrical properties. These can be combined to create a system of first-order nonhomogenous ODEs:

$$X = AX + B$$

Where

$$X = \begin{bmatrix} v_x \\ i \end{bmatrix} \quad A = \begin{bmatrix} 0 & \frac{K_t}{r_w \eta \left[m + \left(\frac{1}{r_w^2} \right) \left(J_2 + \frac{J_1}{\eta} \right) \right]} \\ \frac{-K_B}{r_w \eta L} & \frac{-R}{L} \end{bmatrix} \quad B = \begin{bmatrix} \frac{mg \sin(\theta)}{m + \left(\frac{1}{r_w^2} \right) \left(J_2 + \frac{J_1}{\eta} \right)} \\ \frac{V_{emf}}{L} \end{bmatrix}$$

This becomes the foundation for a mathematical model of the vehicle whose solution will provide an expression for the current and velocity as a function of time. The contents of matrix A and B are constants, and therefore a solution for the ODEs exists. Since the goal is to gain insight into quantifying the energy recovered, appropriate numerical values will be established for the various model parameters.

The scaling of the numerical parameters is based on a golf cart as opposed to a typical passenger vehicle. At this point Matlab from MathWorks will be used to solve the ODEs and provide numerical data that can be used to calculate power flow under specific conditions.

Table: Parameters, units, descriptions, values for electric vehicle regeneration model

Parameter	Units	Description	Value
M	kg	Total mass of vehicle	200
K_t	Nm/Amp	Motor torque constant	1.2
K_B	V*sec/radian	Motor backEMF constant	0.12
R	Ohms	Resistance of motor windings	9
R_w	meters	Wheel radius	0.18
G	m/sec ²	Acceleration of gravity	9.81
J_1	kg*m ²	Moment of inertia of motor plus motor gear	0.01
J_2	kg*m ²	Moment of inertia of four wheels plus wheel gear	1.4
L	Henrys	Inductance of motor	0.002
V_{batt}	Volts	Battery voltage	48
η	None	Gear ratio (r_1/r_2)	1/20
θ	Radians	Downward slope of hill	0.1

Regeneration can exist as a steady-state condition. To set up the model to run under those conditions, the initial state of the vehicle is sitting on the downward slope of a hill with the parking brake engaged. The motor drive stage is disabled such that all MOSFETs are open (not conducting). This means there is no potential for current flow in the motor since there is no path for that current to flow along. The parking brake is now disengaged ($t_0=0$), and the vehicle begins to accelerate down the hill. The motor also begins to rotate and generate BackEMF voltage; however, this does not produce any current since the MOSFETs are still open. There is no braking of any kind occurring in this state.

After 8 seconds ($t_1=8$) the vehicle has accelerated up to about 14 mph (see Figure 7), at which point the drive stage is enabled and running with a constant duty cycle of 25%. The BackEMF voltage of the motor will now produce current since a path exists for the current to flow in. Also note that the BackEMF voltage is larger than the effective voltage, which means the current will grow negative. It reaches a value of -8 Amps almost immediately (within 8 ms) (t_{1+}). However, this current will cause the motor to produce a braking torque that slows down the vehicle, thus reducing the BackEMF voltage. The force of gravity will keep the absolute BackEMF voltage above the effective voltage (which has opposite polarity). This will permit a steady-state condition to exist where velocity is positive, current is negative, and the effective voltage is positive (t_{ss}). Figure 7 follows.

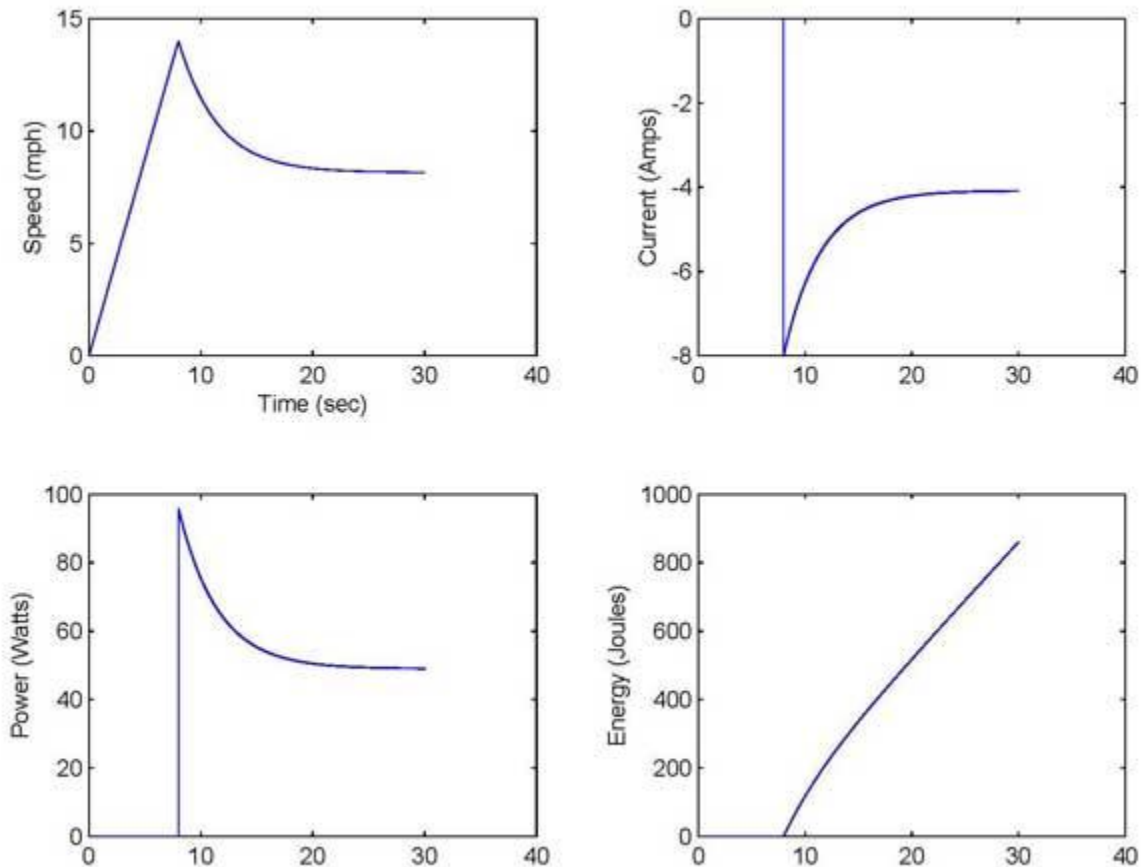
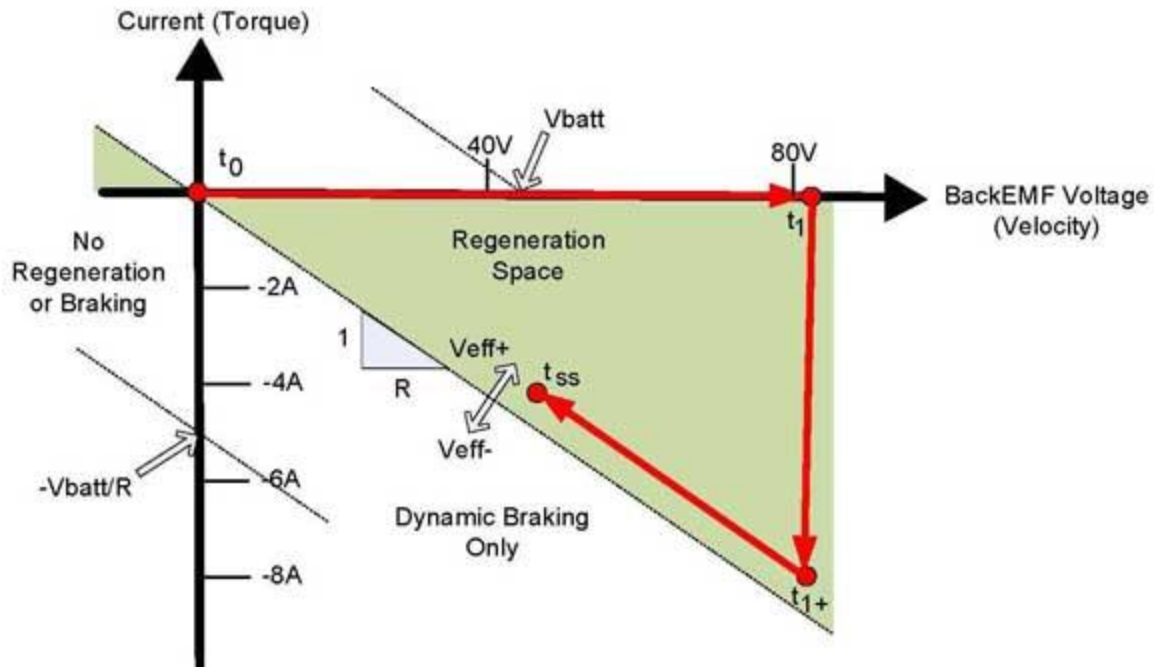

Figure 8 shows the various states that have transpired while running this model, beginning with t_0 and ending with t_{ss} . Regeneration begins as soon as the drive stage (MOSFETs) is enabled, which allows the BackEMF voltage to produce current. After about 10 seconds the speed and

current are almost at steady state. The model is now in a steady-state region of regenerative braking. Figure 8 is below.



At the end of the section pertaining to the H-bridge analysis, it was concluded that the average power flow into the battery can be defined by the battery voltage times the current times the duty cycle percentage.

$$P = V_{batt} * I * DutyCycle$$

The steady-state current is about -4 amps and subsequently the power flow is about 48 W. However, the typical efficiency of a lead acid battery is 75%-85%. This means that only a percentage of the energy flowing into the battery will be stored as electrical energy that can be later used. The remainder of the power is lost due to thermal heating. In this case, the rate of energy being stored that can later be used is about 35-40 W. Further limitations arise as a result of battery properties, one of which being that the recharge efficiency will reach zero when fully charged.

UNIT-5

HYBRID ELECTRIC VEHICLES

Series and parallel circuits

Components of an electrical circuit or electronic circuit can be connected in many different ways. The two simplest of these are called series and parallel and occur frequently. Components connected in series are connected along a single path, so the same current flows through all of the components.^{[1][2]} Components connected in parallel are connected along multiple paths, so the same voltage is applied to each component.^[3]

A circuit composed solely of components connected in series is known as a series circuit; likewise, one connected completely in parallel is known as a parallel circuit.

In a series circuit, the current through each of the components is the same, and the voltage across the circuit is the sum of the voltages across each component.^[1] In a parallel circuit, the voltage across each of the components is the same, and the total current is the sum of the currents through each component.^[1]

Consider a very simple circuit consisting of four light bulbs and one 6 V battery. If a wire joins the battery to one bulb, to the next bulb, to the next bulb, to the next bulb, then back to the battery, in one continuous loop, the bulbs are said to be in series. If each bulb is wired to the battery in a separate loop, the bulbs are said to be in parallel. If the four light bulbs are connected in series, there is same current through all of them, and the voltage drop is 1.5 V across each bulb, which may not be sufficient to make them glow. If the light bulbs are connected in parallel, the currents through the light bulbs combine to form the current in the battery, while the voltage drop is across each bulb and they all glow.

In a series circuit, every device must function for the circuit to be complete. One bulb burning out in a series circuit breaks the circuit. In parallel circuits, each light has its own circuit, so all but one light could be burned out, and the last one will still function

Series circuits are sometimes called *current-coupled* or *daisy chain-coupled*. The current in a series circuit goes through every component in the circuit. Therefore, all of the components in a series connection carry the same current. There is only one path in a series circuit in which the current can flow.

A series circuit's main disadvantage or advantage, depending on its intended role in a product's overall design, is that because there is only one path in which its current can flow, opening or breaking a series circuit at any point causes the entire circuit to "open" or stop operating. For example, if even one of the light bulbs in an older-style string of Christmas tree lights burns out or is removed, the entire string becomes inoperable until the bulb is replaced.

Current[edit]

In a series circuit the current is the same for all of the elements.

Resistors[edit]

The total resistance of resistors in series is equal to the sum of their individual resistances:

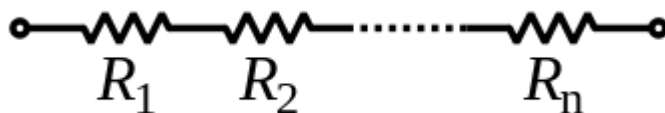

Electrical conductance presents a reciprocal quantity to resistance. Total conductance of a series circuits of pure resistors, therefore, can be calculated from the following expression:

For a special case of two resistors in series, the total conductance is equal to:

Inductors[edit]

Inductors follow the same law, in that the total inductance of non-coupled inductors in series is equal to the sum of their individual inductances:

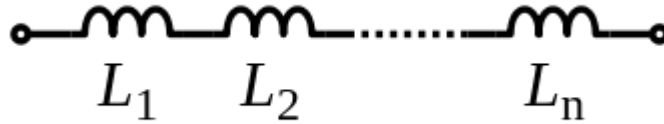

However, in some situations it is difficult to prevent adjacent inductors from influencing each other, as the magnetic field of one device couples with the windings of its neighbours. This influence is defined by the mutual inductance M . For example, if two inductors are in series, there are two possible equivalent inductances depending on how the magnetic fields of both inductors influence each other.

When there are more than two inductors, the mutual inductance between each of them and the way the coils influence each other complicates the calculation. For a larger number of coils the total combined inductance is given by the sum of all mutual inductances between the various coils including the mutual inductance of each given coil with itself, which we term self-inductance or simply inductance. For three coils, there are six mutual

inductances M_{12} , M_{21} , and M_{13} , M_{31} , and M_{23} , M_{32} . There are also the three self-inductances of the three coils: L_1 , L_2 , and L_3 .

Therefore

By reciprocity $M_{12} = M_{21}$ so that the last two groups can be combined. The first three terms represent the sum of the self-inductances of the various coils. The formula is easily extended to any number of series coils with mutual coupling. The method can be used to find the self-inductance of large coils of wire of any cross-sectional shape by computing the sum of the mutual inductance of each turn of wire in the coil with every other turn since in such a coil all turns are in series.

Capacitors[edit]

See also: Capacitor § Networks

Capacitors follow the same law using the reciprocals. The total capacitance of capacitors in series is equal to the reciprocal of the sum of the reciprocals of their individual capacitances:

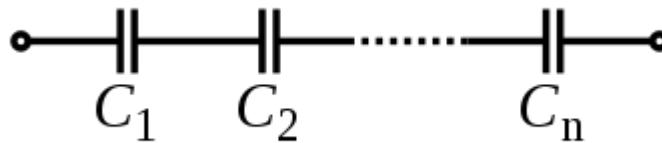

Switches[edit]

Two or more switches in series form a logical AND; the circuit only carries current if all switches are closed. See AND gate.

Cells and batteries[edit]

A battery is a collection of electrochemical cells. If the cells are connected in series, the voltage of the battery will be the sum of the cell voltages. For example, a 12 volt car battery contains six 2-volt cells connected in series. Some vehicles, such as trucks, have two 12 volt batteries in series to feed the 24 volt system.

Parallel circuits[edit]

If two or more components are connected in parallel they have the same potential difference (voltage) across their ends. The potential differences across the components are the same in magnitude, and they also have identical polarities. The same voltage is applicable to all circuit components connected in parallel. The total current is the sum of the currents through the individual components, in accordance with Kirchhoff's current law.

Voltage[edit]

In a parallel circuit the voltage is the same for all elements.

Current[edit]

The current in each individual resistor is found by Ohm's law. Factoring out the voltage gives

. *Drivetrain*

A drivetrain may be the least understood part of a vehicle. This is due to several factors, including the fact that the term “drivetrain” is often used interchangeably with powertrain and driveline.

The drivetrain includes the transmission, the driveshaft, the axles, and the wheels. Simply put, it works in conjunction with the engine to move the wheels. The drivetrain system is an essential component of a vehicle and the transmission is an integral part of the drivetrain.

The Drivetrain and the Transmission

The drivetrain and the transmission are actually two very different concepts. The main function of the transmission is similar to the chain on a bicycle: it keeps the engine turning in time with the wheels, regardless of what gear the vehicle is in. The drivetrain represents everything that is behind the transmission involved in propelling the vehicle. The main function of the drivetrain is basically to convey power from the vehicle's engine, through the transmission to the drive wheels on the vehicle to control the amount of torque. "Torque" is turning or twisting force.

Parts of a Drive train

The drivetrain is comprised of a collection of components in a vehicle that transfer power from the transmission to the wheels/ drive it forward. These components include the driveshaft, CV joints, the differential, the axle shafts and the U-joints.

- A driveshaft is a long tube of steel that is linked to a car's transmission at one end and the wheels at the other. It transfers the mechanical power from the transmission to the other components of the vehicle.
- A U-joint, or universal joint, is a flexible pivot point that transmits power allowing for varying angles of the driveshaft.
- CV joints, or constant-velocity joints, are part of the driveshaft. These joints are designed to be able to bend in any direction while continuing to turn the drive wheels at a constant velocity.

- The differential is where the power makes its last stop before spinning the wheels (see ‘How Differentials Work’).
- Axle shafts are a single rotating shaft, on either side of the differential, which delivers power from the final drive assembly to the drive wheels.

Driveline, Drivetrain, Powertrain

Technicians sometimes refer to driveline, drivetrain and powertrain interchangeably when referring to the drivetrain system of an automobile. This can cause confusion, but in essence, all of these terms describe the same system within the vehicle.

The powertrain in a vehicle is composed of everything that makes the vehicle move. This includes everything from the engine to the transmission to all the parts that allow the power from the engine to get to the wheels. A vehicle’s driveline consists of all of the powertrain’s components except for the engine.

The drivetrain is the part of a motorized vehicle which connects the engine and transmission to the wheel axles.

The driveline includes everything in the chain from the engine to the drive wheels, but the drivetrain consists of everything after the transmission — all driveshafts, axles, joints, differentials and wheels.

Mister Transmission technicians are all certified drivetrain and transmission specialists who service drivetrain and transmission issues in all modern vehicles.